



16 Channel Programmable Delay

D16G

General Description

The D16G is a custom designed 16-channel programmable delay circuit. Each channel consists of an input LVDS-to-CMOS level converter; four stages of delay with 1, 2, 4, and 8 steps; and output width pulse shaper. Also, the chip has the possibility to generate a test level at each output. This option is used for testing chip-to-chip connections. The chip has a serial interface to control the delay and set the output test level.

The D16G is designed and fabricated using a CMOS 0.5 micron technology.

The chip is capsulated into a QFP-64L 10X10 plastic package.

This ASIC is designed as a part of the anode front-end electronics for Cathode Strip Chambers of the Endcap of the Muon System of CMS experiment.

Features

Input signal level	LVDS standard
Input resistance	110 Ohm
Output signal	3.3 V CMOS
Number of delay steps	15
Delay step (slope)	1- 4 ns (adjustable with an external current)
Output pulse width	40 ns (adjustable with an external current)
Power supply voltage	3.3 V
Power consumption	0.2 W
Temperature drift	0.6 ns/10°C

Block Diagram

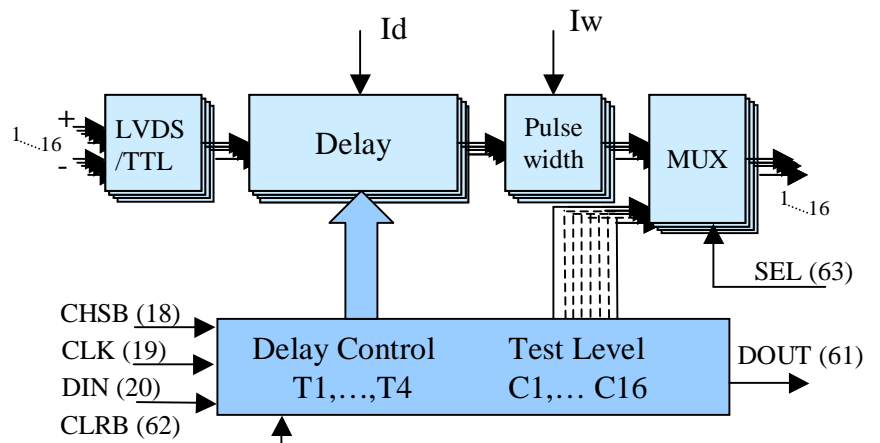

Top View

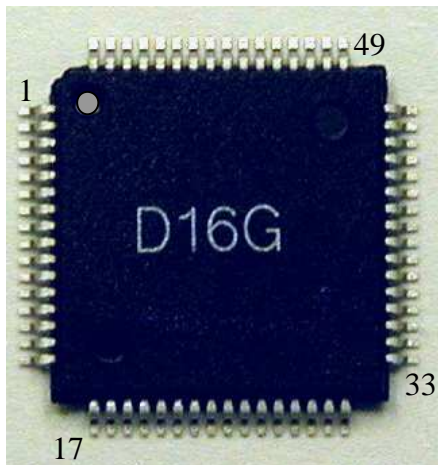

Size: 10 mm x 10 mm x 1 mm.

Pin pitch: 0.5 mm.

16 Channel Programmable Delay

D16G

Pin Configuration

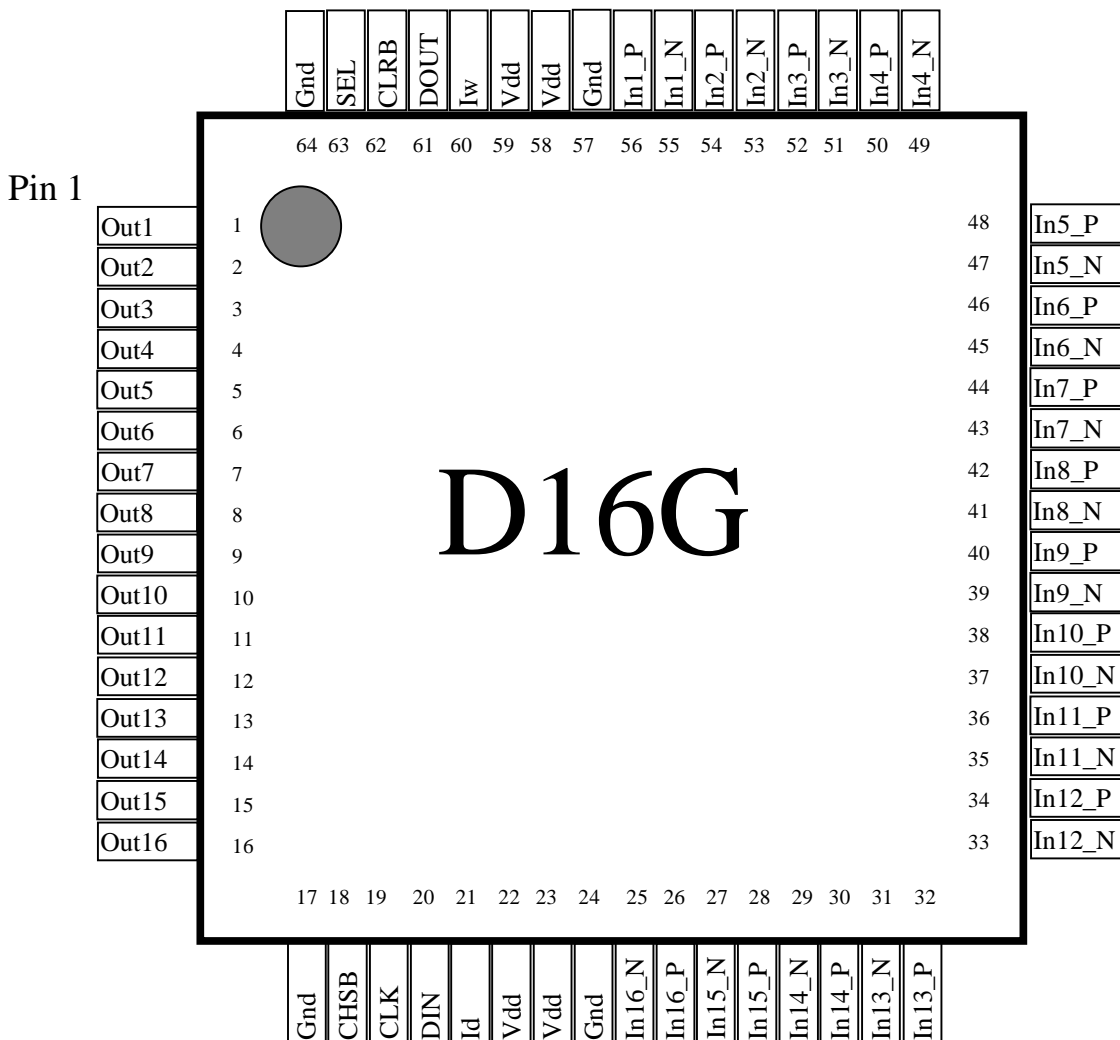

16 Channel Programmable Delay

D16G

Electrical Characteristics

PARAMETER	SYMBOL	CONDITIONS	MIN	TYP	MAX	UNITS
Input signal level			LVDS standard			
Input impedance	R_{inp}			110		Ohm
Output signal			3.3 V CMOS			
Minimum delay	T_{del.min}	Pin I_d connected to Gnd via 10K, delay code 0	19	22	24	ns
Delay step (slope)	S_d	Adjustable with an external current	1		4	ns/LSB
Number of delay steps				15		
Delay nonlinearity				S_d/2		ns
Channel-to-channel difference within chip	dT				S_d	ns
Output pulse width	T_{pulse}	Pin I_w connected to Gnd via 20K.		40		ns
Output pulse rise time		Load capacitance 15 pF		4		ns
Output pulse fall time		Load capacitance 15 pF		4		ns
Output current	I_{out}			15		mA
Power supply voltage	V_{dd}			3.3		V
Power consumption	P				0.2	W

16 Channel Programmable Delay

D16G

Test Performance

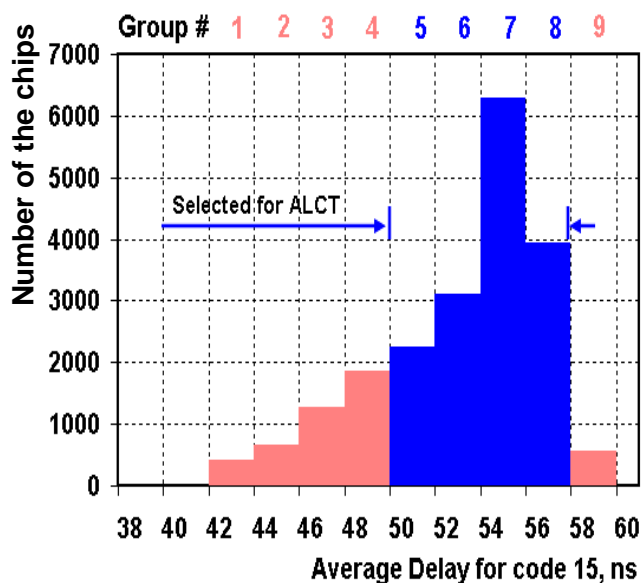

Delay chip distribution vs. delay at code 15.

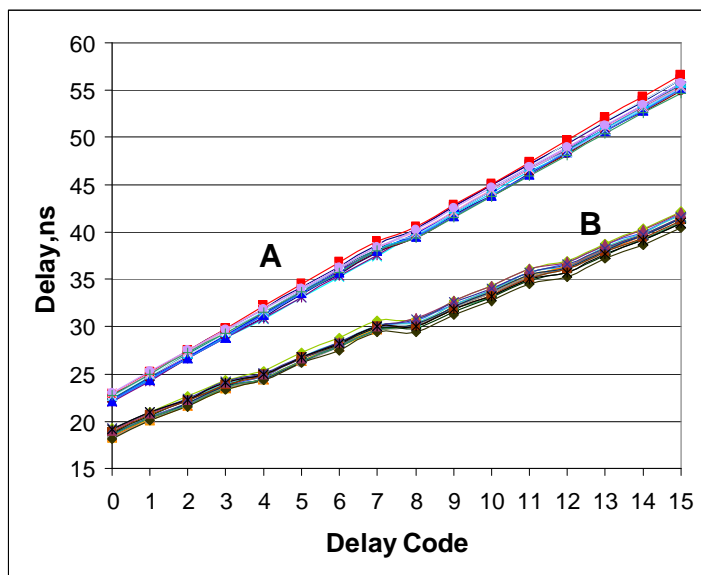

Typical samples of delay vs. delay code.
A – group 7, delay slope 2.2 ns/LSB
B – group 1, delay slope 1.5 ns/LSB

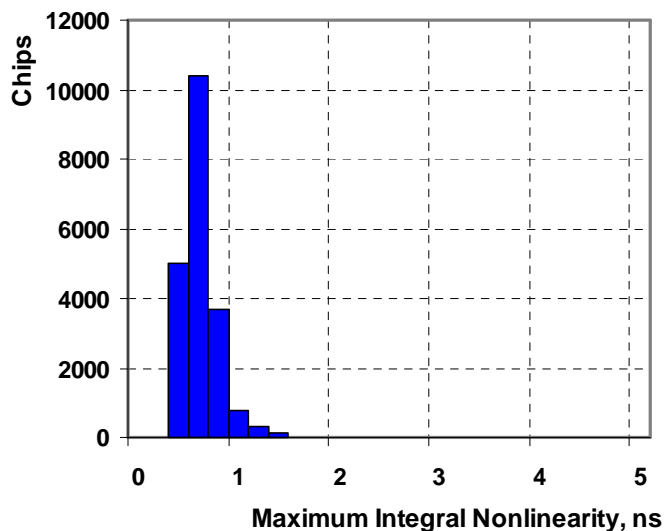
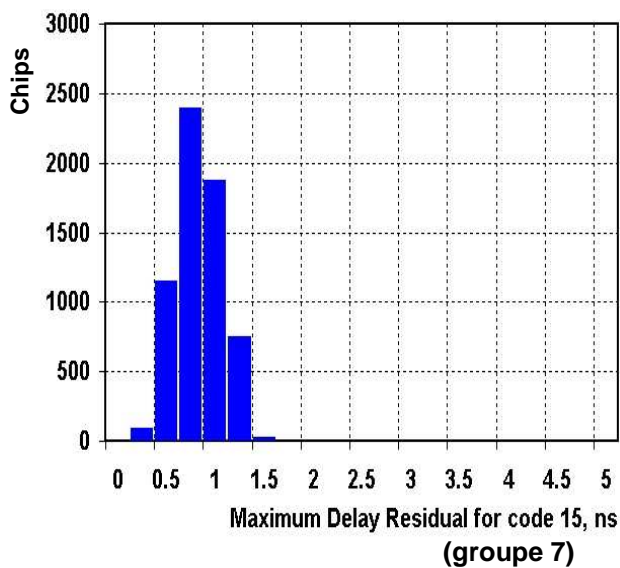

16 Channel Programmable Delay

D16G

Temperature dependence

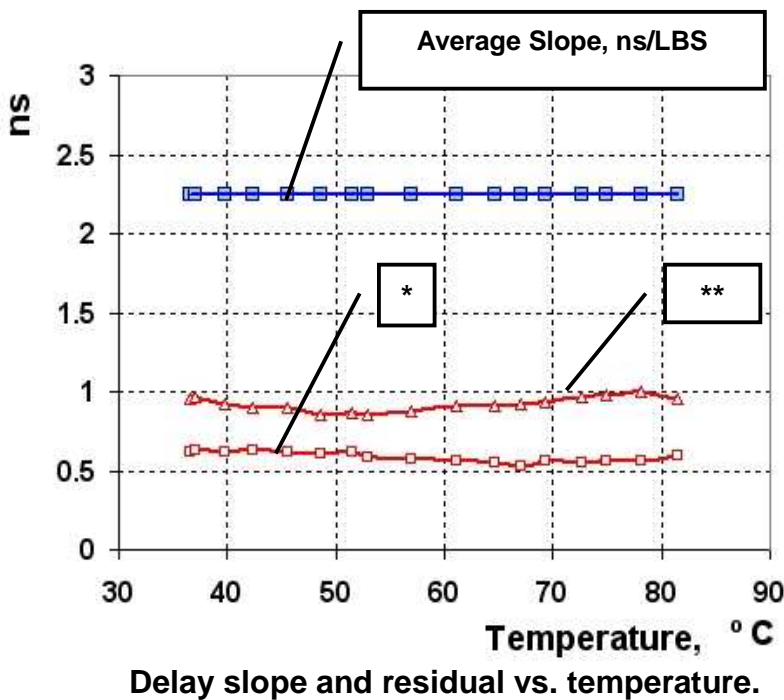
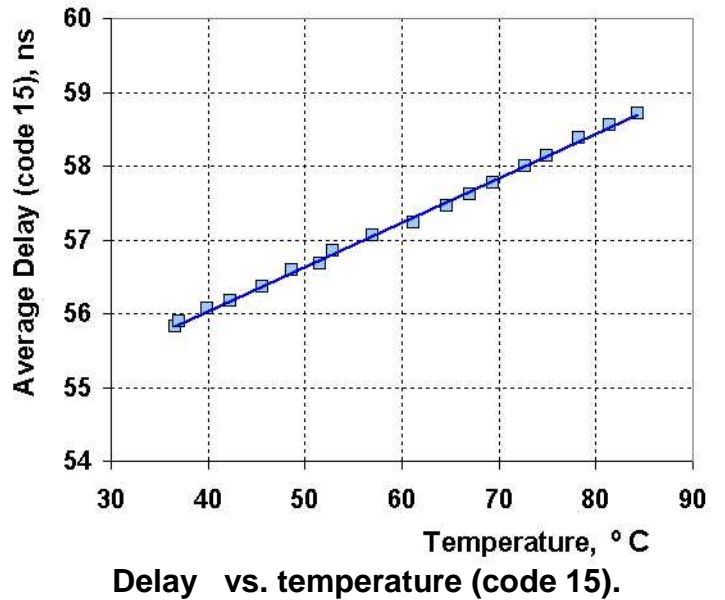
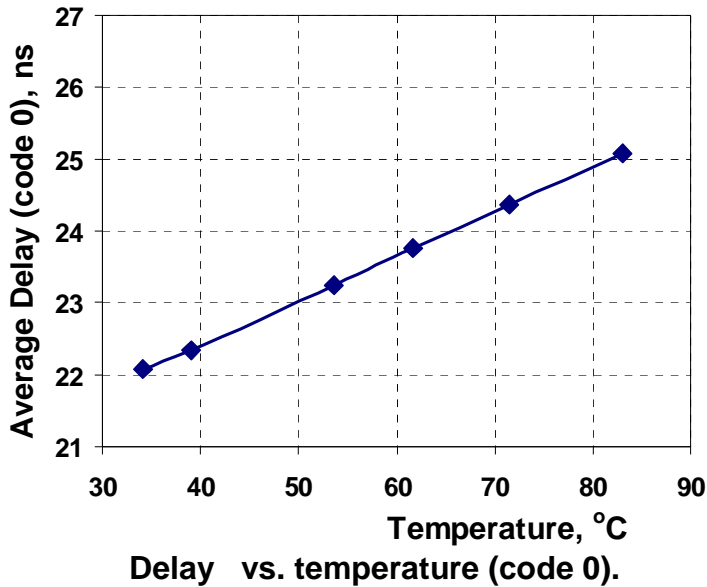

Temperature range 36 °C - 85 °C
 Delay drift rate - 0.6 ns / 10 °C

- *) Maximum delay residual for code 0
- ***) Maximum delay residual for code 15

16 Channel Programmable Delay

D16G

Delay Slope Tuning by Voltage

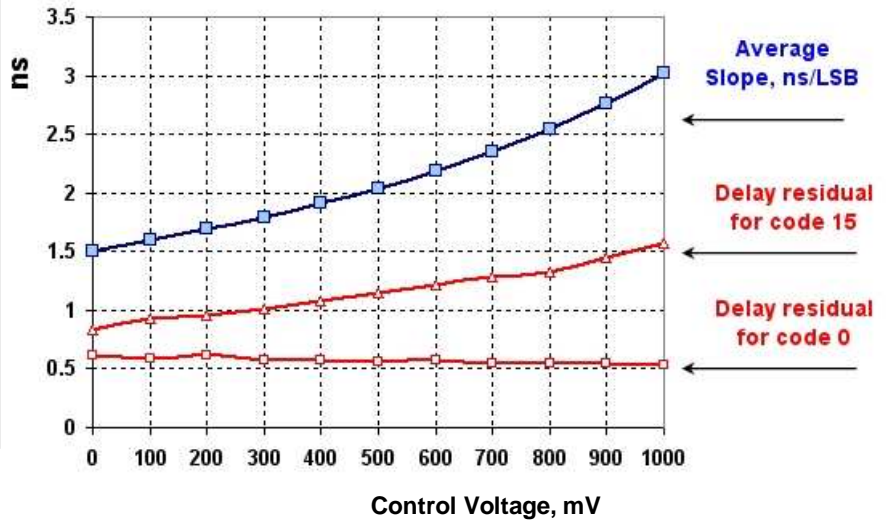
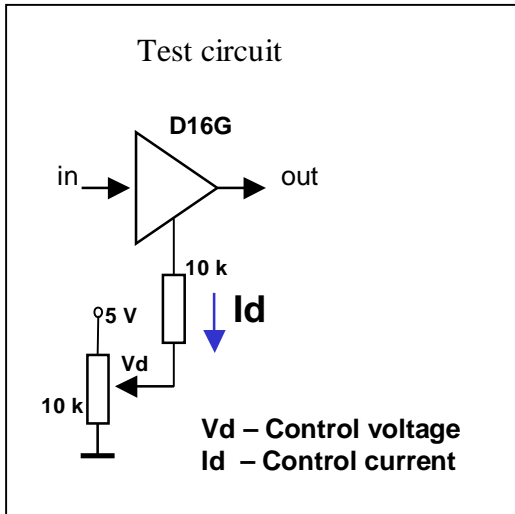

Delay (Va) @ code 0 = constant
 Delay (Va) @ code 15 = 1.42 ns / 100 mV
 Slope (Va) = 0.10 ns / 100 mV

Delay slope vs. Control Voltage.

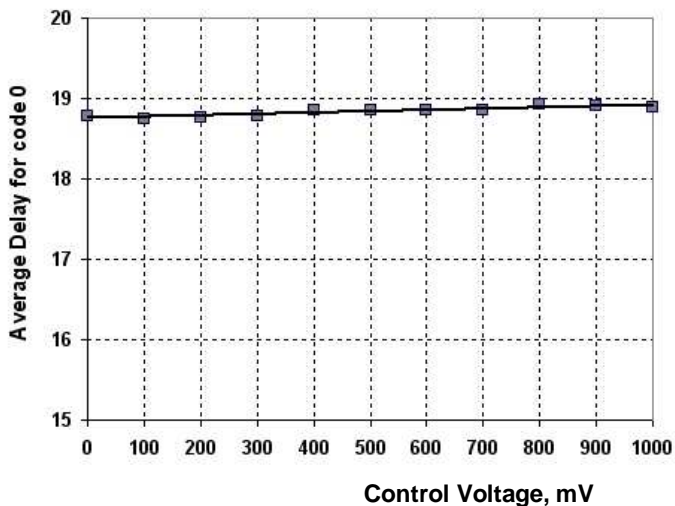

Minimum delay (delay code 0) vs. Control Voltage.

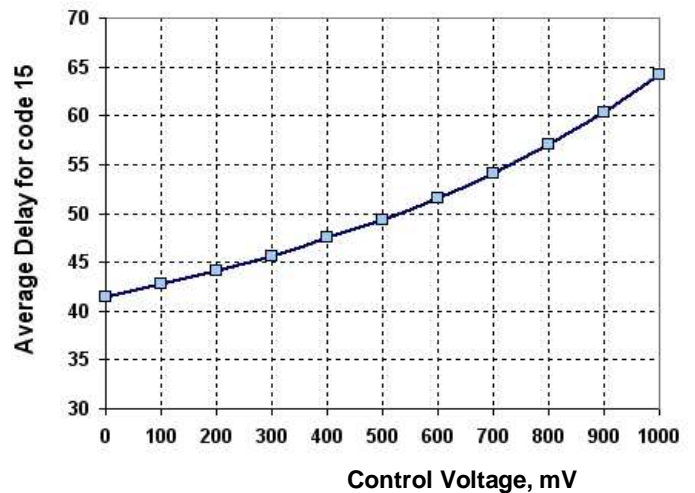

Maximum delay (delay code 15) vs. Control Voltage.

16 Channel Programmable Delay

D16G

Delay Slope Tuning by Current

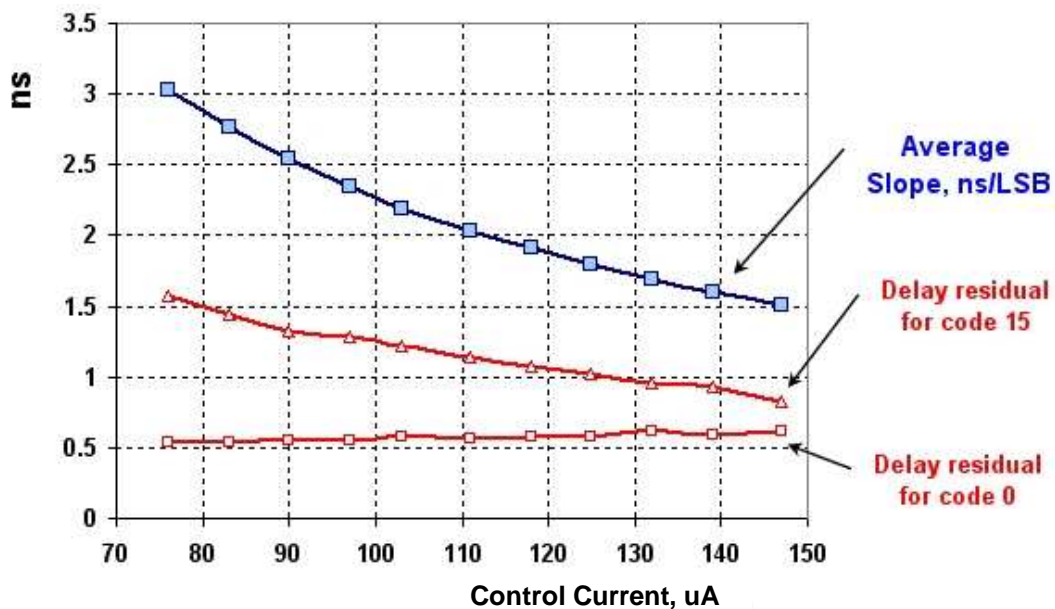

Delay slope vs. Control Current.

Delay (1a) @ code 0 = constant
 Delay (1a) @ code 15 = - 1.93 ns/ 10 μ A
 Slope (1a) = - 0.13 ns / 10 μ A

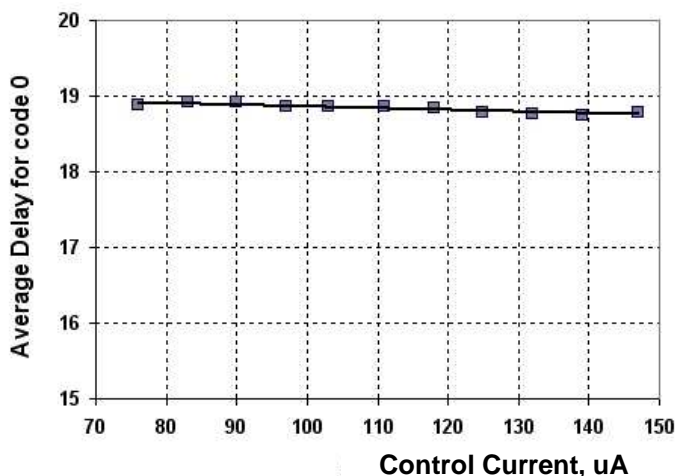

Minimum delay (delay code 0) vs. Control Current.

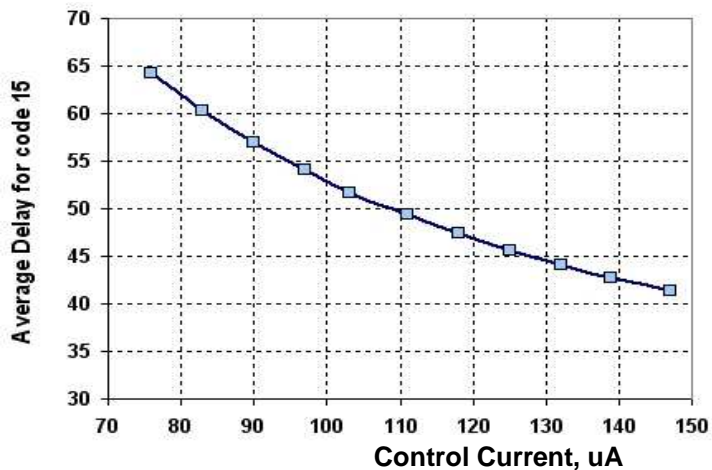

Maximum delay (delay code 15) vs. Control Current.

16 Channel Programmable Delay

D16G

Single-Channel Structure

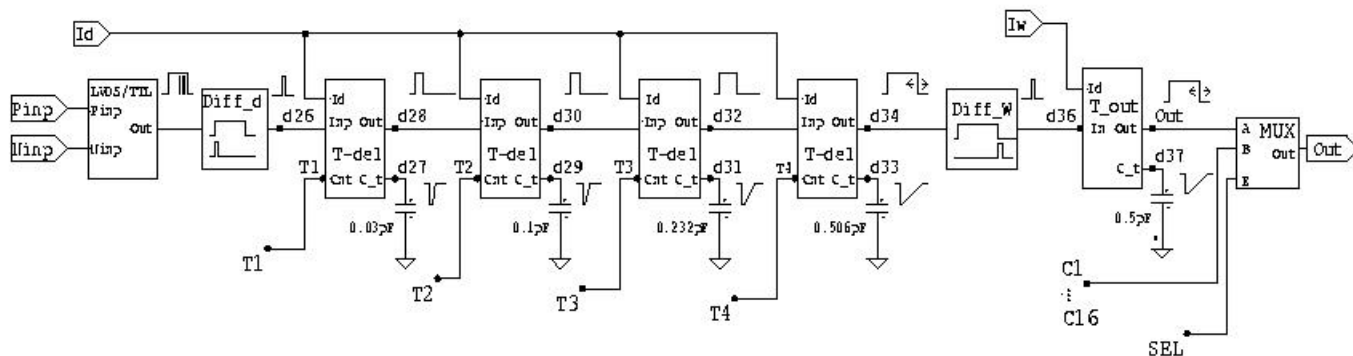

Time diagram:

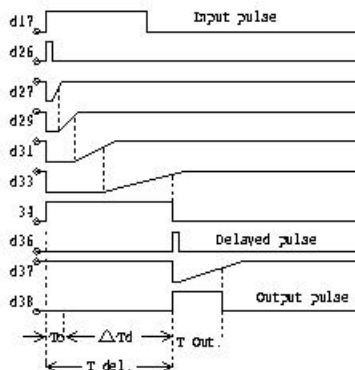

Delay for chip:

$$T_{del} = T_0 + \Delta T_d$$

T_0 - minimal delay of the delay circuit

$$\Delta T_d = \Delta T_1 + \Delta T_2 + \Delta T_3 + \Delta T_4$$

Delay for each stage :

$$\Delta T_i = C_i * \Delta U / I_d, \quad i=1,2,3,4$$

Output pulse width:

$$\Delta T_{out} = C_{out} * \Delta U / I_w$$

ΔU - Trigger Smith threshold

ΔT_i - delay time for each stage

C_i - delay capacitors

C_{out} - Output pulse shaping capacitor

I_d - delay circuit charging current

I_w - output pulse shaping capacitor

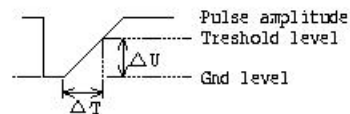

Multiplexer logic table.

E	A	B	Out
0	0	X	0
0	1	X	1
1	X	0	0
1	X	1	1

16 Channel Programmable Delay

D16G

Control Logic

