



Aging Effects in Cathode Strip Chambers of CMS at Large Hadron Collider: Chemistry and Recovery

GIF++&ATS

CSCs longevity study

- I. Aging studies in CSC CMS.
- II. Malter current in LHCb muon chambers:
 - statistic;
 - recovery methods.
- III. Malter currents: examples observed at CSC CMS .
- IV. Malter currents: observation at GIF++ .
- V. Targeting aging test in PNPI:
 - Aging test results;
 - SEM/XEM analysis.
- VI. Aggravation of aging problems by limitation of GHG.
- VII. Conclusion.

Compact Muon Solenoid (CMS) at Large Hadron Collider (LHC)

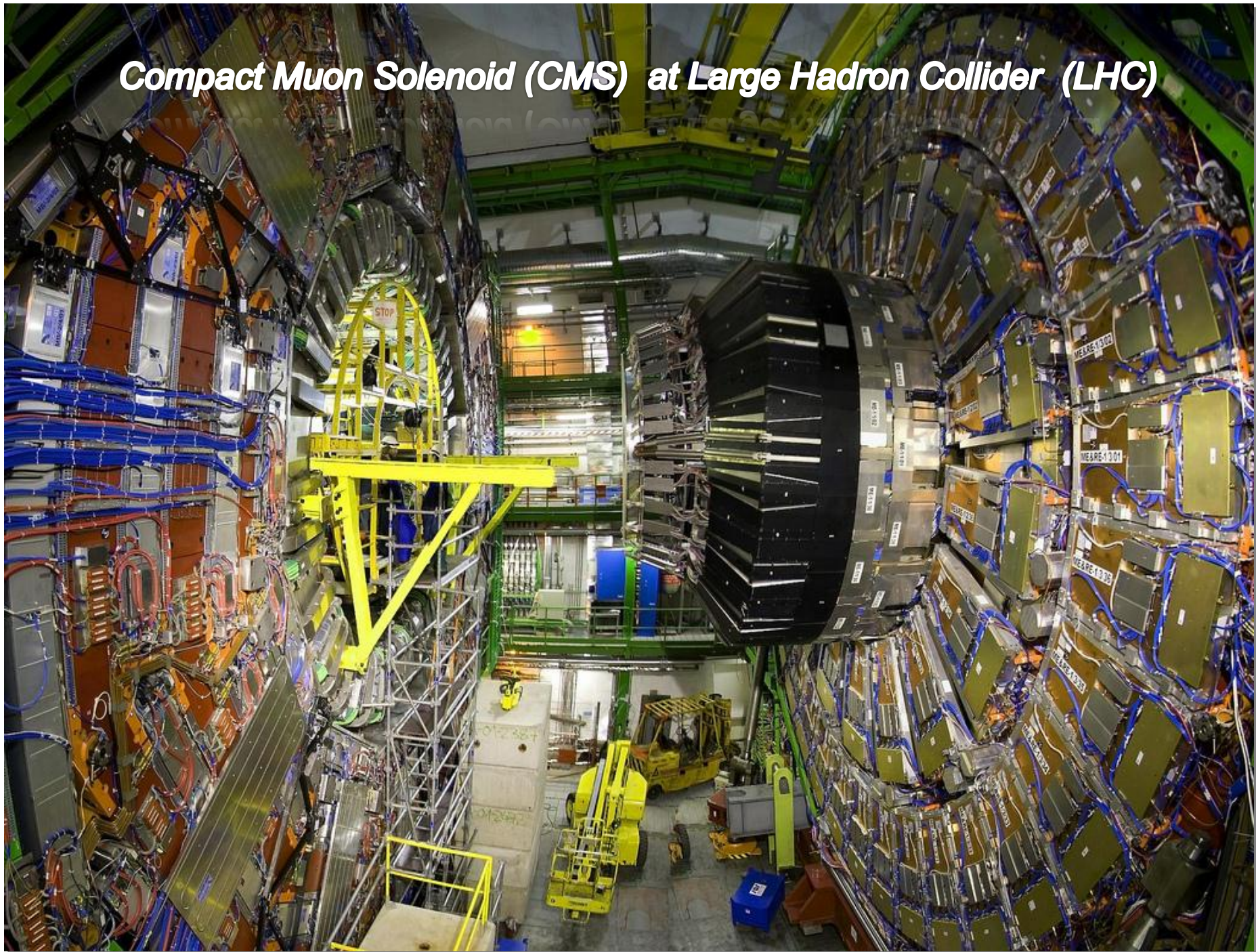



Historical summary: CSC CMS, Ar/CO₂/CF₄ (40 : 50 : 10)

- 1998 – Local aging test of first CSC prototype (⁹⁰Sr - Q~12 C/cm, 75 Volume/day+ Q~2 C/cm 1 Volume/day);
- 1999 - Aging test of 1m prototype on GIF (¹³⁷Cs – Q=0.218 C/cm, 1 Volume/day);
- 2000-2001 - Aging test of full-scale CSC chamber on GIF (¹³⁷Cs – Q=0.35 C/cm, 1 Volume/day);
- 2010 – First signs of MCE in the ME1/1 (V.Perelygin DOC Report 25.04.2012).
- From 2016 – Ongoing aging test of full-scale CSC chamber on GIF++ (¹³⁷Cs – Q ~ 0.175 C/cm, 1 Volume/day);
- 2016 - Local benchmark aging test of CSC prototype (⁹⁰Sr – Q ~ 1.36 C/cm, 3.5 Volume/day).

CSC LHCB, Ar/CO₂/CF₄ (40 : 55 : 5)

- 1998 – 2000, M1R2 and M2/3 R1/R2 - 5 regions, passed through the conditioning with HV(-) on GIF before installation (336 gaps). In total –2582 gaps (52.2%);
- 2010 - 2016 Ongoing training procedures for recovering from Malter current.

CSC's Malter current and HL-LHC

Arguments to predisposition to the Malter current effect (MCE)

- Working gas mixture Ar(40%) CO₂(50%) CF₄(10%) in CSC's longevity tests demonstrated perfect protection of the anode wires.
- BUT. Presence of CF₄ in gas mixture does not prevents cathode surface from occurrence of the insulating layer . Therefore with dose accumulation and start of HL-LHC beam the CSC degradation danger is mainly related with Malter effect.**
- Early diagnostic with monitoring HV system and training procedure to cure MCE have to be developed.



CSC Endcap Muon System

2 endcaps
 4 stations (disks) in z
 2 or 3 rings in radius
 540 chambers
 6000 m² active area
 2.5 million wires
 0.5 million channels

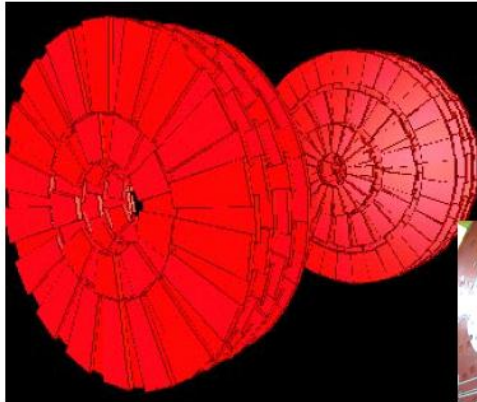

Chambers overlap in ϕ and η

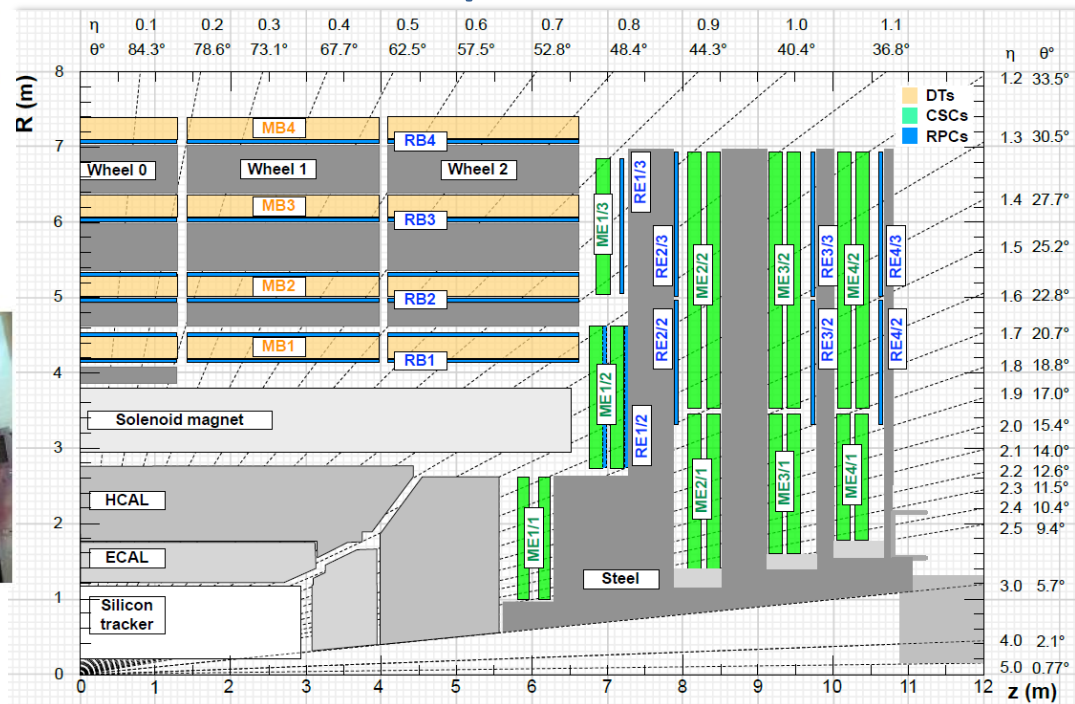

Effective luminosity determined from current on anode wires

Anode current is proportional to luminosity (example from ME2/1)

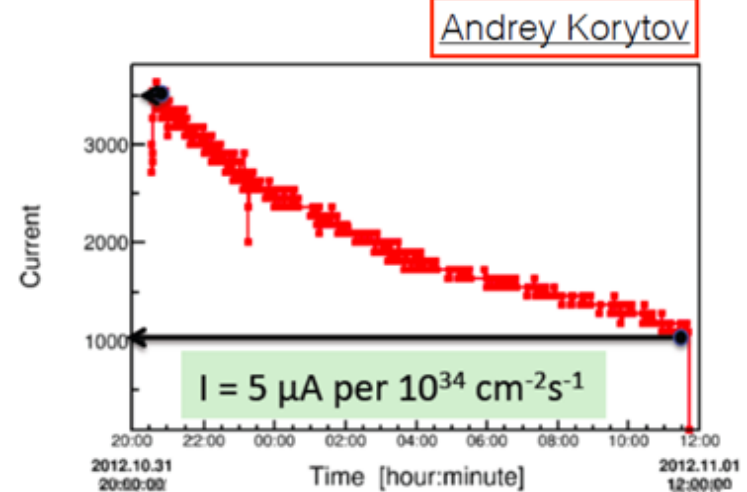
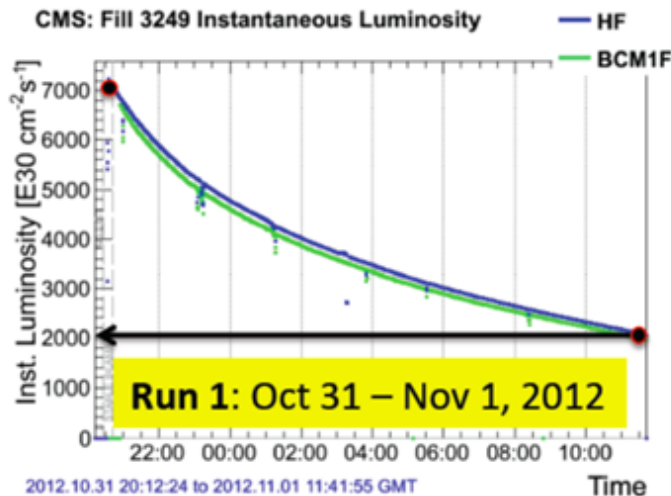

Arguments to predisposition
to the Malter current effect
(MCE)

- **Currents observed in Run 1 and Run 2**
 - ME1/1: $I \approx 2 \mu\text{A per } 10^{34} \text{ cm}^{-2} \text{ s}^{-1}$
 - ME2/1 (HV#1): $I \approx 5 \mu\text{A per } 10^{34} \text{ cm}^{-2} \text{ s}^{-1}$
 - Current per lumi is about the same at 8 and 13 TeV
- **Extrapolation toward HL LHC $L = 5 \times 10^{34} \text{ cm}^{-2} \text{ s}^{-1}$**
 - ME1/1: $I_{\text{HL-LHC}} \approx 10\text{-}15 \mu\text{A}$
 - ME2/1 (HV#1): $I_{\text{HL-LHC}} \approx 25 \mu\text{A}$

Malter current effect is ...

Malter current effect (MCE) is secondary electron emission which appears when:

1. an insulating layer exists on the cathode,
2. the rate of ion build-up is higher than its removal from the insulating layer,
3. some ignition mechanism take place

Manifestation of MCE:

1. self-sustained discharge ignited by high intensity irradiation and micro sparks;
2. sustained $O(1) \mu\text{A}$ current independent from external irradiation;
3. spurious signals which hard to see in data or DQM (can be too small, DAQ is LST driven).

Curing is possible:

- Make cathode again conductive by
 - Adding water/alcohol vapours (not good for FR4 cathode strips);
 - Clean (etch) insulating layer with training at presence of $\text{O}\bullet$, $\text{F}\bullet$ and $\text{CF}_3\bullet$
- Wait until insulating layer rises up to $1 \mu\text{m}$ (??)

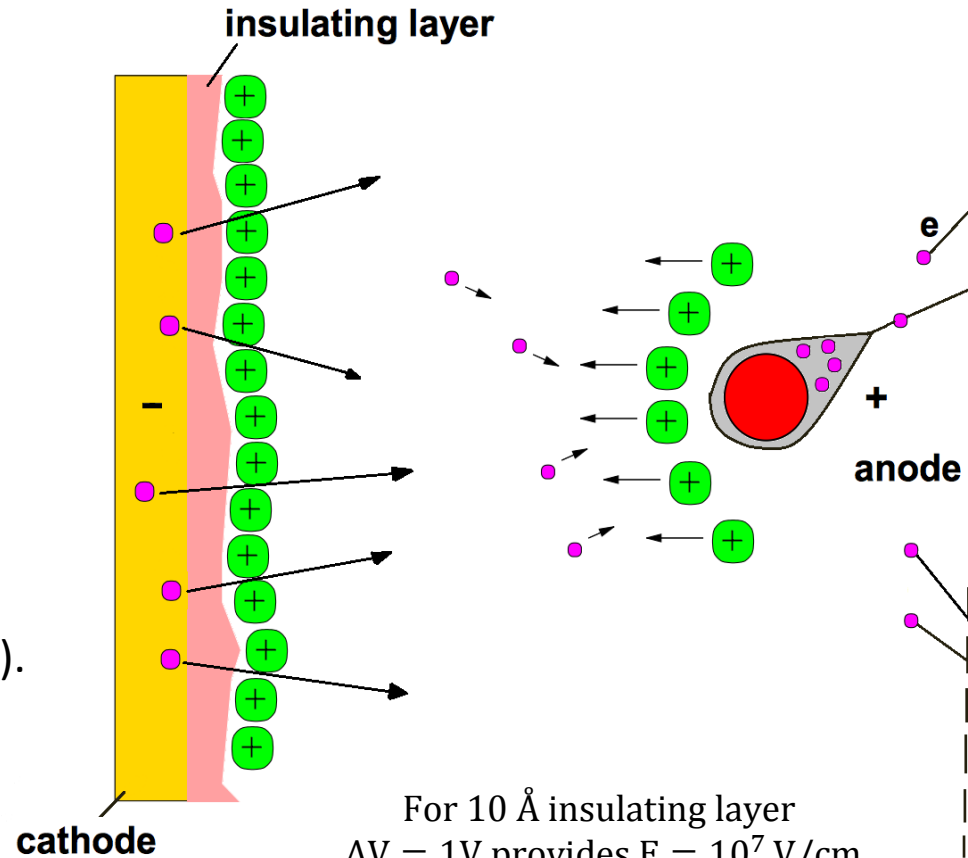

Malter currents: relevance for us

Andrey Korytov (UF)
September 13, 2016
CSC Meeting (CMS Physics Week)

- **LHCb reports serious problems in their muon CSCs**
 - see the talk by Oleg Maev at the GIF++ meeting on Aug 23
- **ME1/1 CSCs: we saw Malter currents at P5 (e.g., three chambers were replaced after Run 1) and also at GIF++**
- **non-ME1/1 CSCs: we did not see Malter currents in Run 1 (but with $O(10,000)$ channels, it would be hard to spot a few channels without having a systematic study)**
- **In Run 2 with $B=0$, we saw many ME1/1, ME1/2, ME1/3, ME2/1 chambers showing large currents looking like Malter currents – this is completely not understood!**
 - see talks by Victor Perelygin, Misha Ignatenko (July 2, July 13, July 19)

Malter current effect (MCE): why worry

- Malter current effect may be assumed as a local current of $1 \mu\text{A}$ per 1 cm of wire length.

Then $dQ/dl = 1 \mu\text{A}/\text{cm} \times 10^7 \text{ s}/\text{year} \times 1 \text{ year} = 10 \text{ C}/\text{cm}$

- **But already at $dQ/dl \sim 2\text{-}4 \text{ C}/\text{cm}$ it is very real to obtain anode wire swelling, that cause a rapid drop of the signal amplitude.**

- That is:

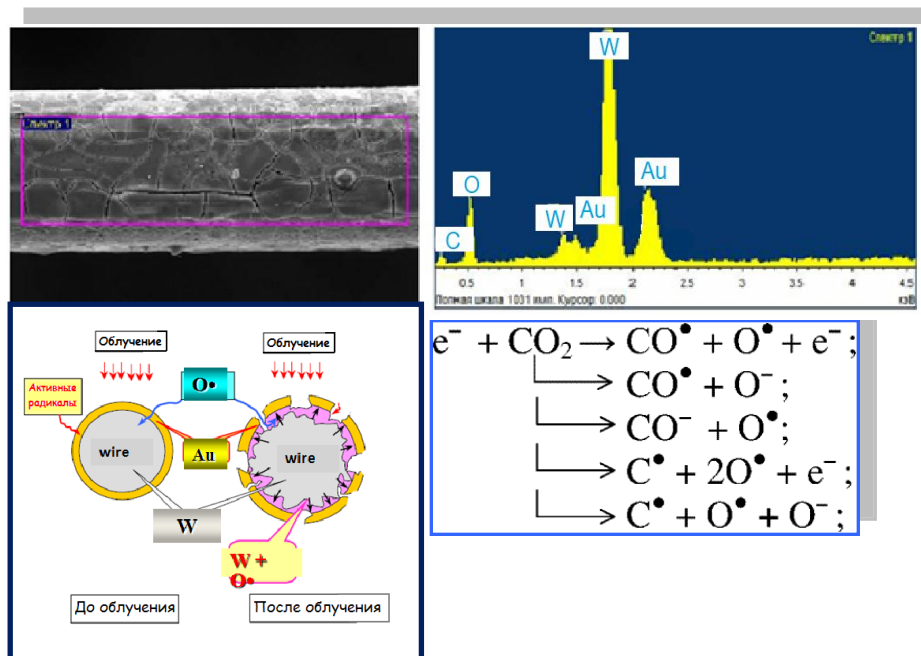

T. Ferguson et al, NIMA 515 (2003) 266–277

T. Akesson et al. NIMA 515(2003) 166-179

Malter currents LHCb CSC: recovery experience and remedies

Since of 2010 the training procedures take place:

- I. during the beam irradiation and continues from few hour up to few days;
- II. without beam with normal and inversed HV that takes up to few weeks and sometimes needs additional treatment with beam;

III. 4 not amendable to recovery modules have been successfully treated using working gas mixture with 2% O₂

2010 – 1.8 % Gaps

2011 – 2.4% Gaps

2012 – 2.8% Gaps

2015 – 0.5% Gaps

12.09.16 – 2.9% (144) Gaps. at the same Lumi as in 2012 but time of operation was very short.

MUON system has 4944 gaps in 1368 MWPCs

Gas mixture -Ar/CO₂/CF₄ (40 : 55 : 5) Gas Gain ~ 46-88 000 at HV 2520-2630V

Oleg Maev, LHCb General meeting, 12 September 2016

LHCb Integrated Luminosity in pp collisions 2010-2016

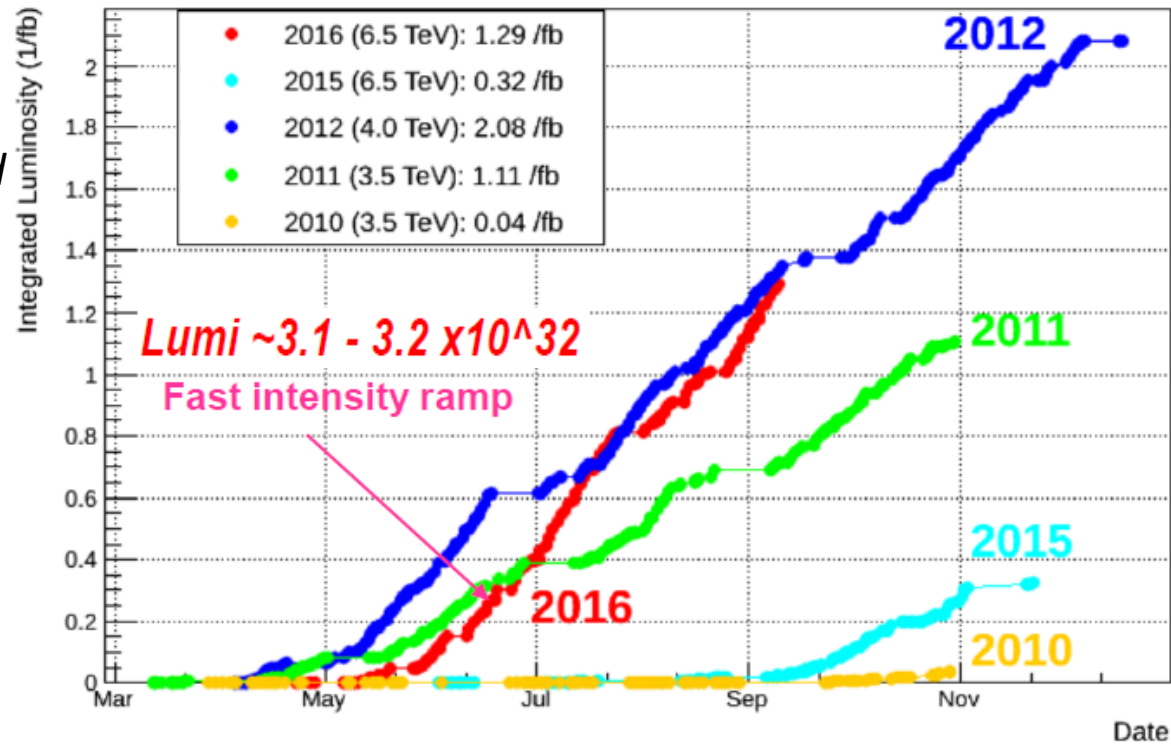

Malter currents MUON LHCb: recovery samples

I. MCE curing procedure on the beam consists in keeping of the Malter current until it drops down at the level below of the HV trip threshold. For the training the threshold is specially raised up to $\sim 40 \mu\text{A}$

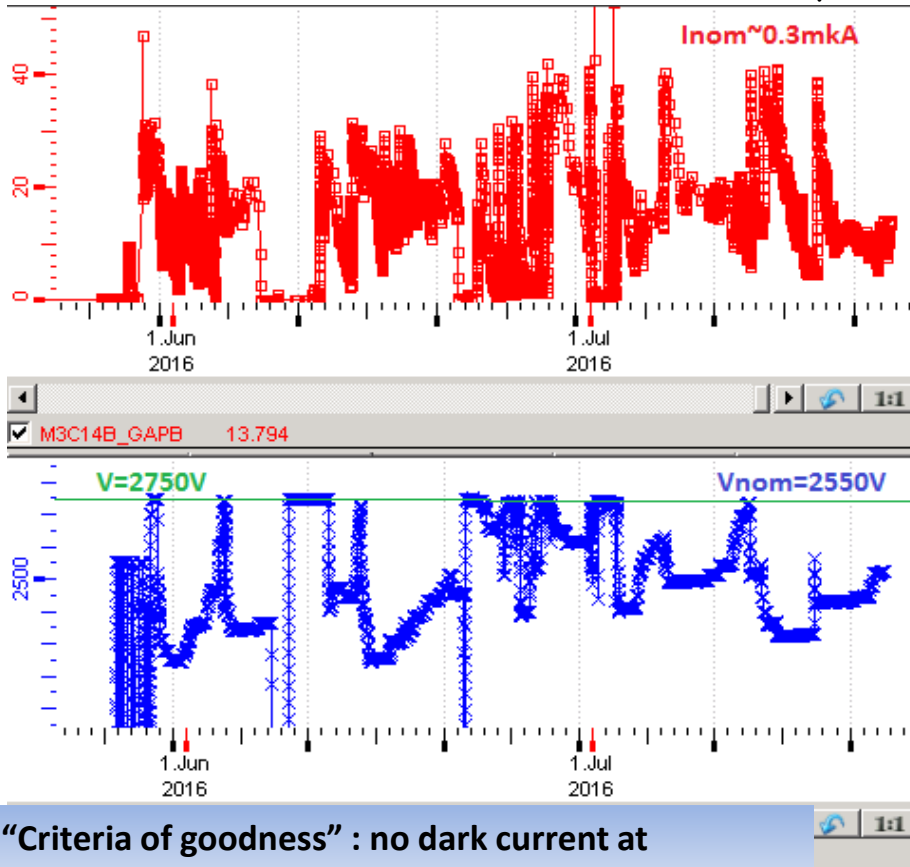

“Criteria of goodness” : no dark current at HV(+)=+2.85kV and HV(-)=-2.3kV

Oleg Maev

II. MCE curing procedure without beam is similar to the previous with beam, but includes the training with inversed high voltage as well.

During each long period for access (>4 days) the most problematic gaps had been treated with negative polarity.

Gas mixture -Ar/CO₂/CF₄

1. CF₄, CO₂ dissociation under interaction with e⁻
=> production of F•, O•, CF₃•



2. => etching of Si, SiO₂ => SiF₄ ↑



3. => desorption of SiF₄ molecules from the cathode due to external irradiation

- The training with HV(-) in situ passed 2354 (47.6%) gaps in MUON system.
- In addition, 5 regions, M1R2 and M2/3 R1/R2, passed through the conditioning with HV(-) on GIF before installation (336 gaps).
- In total -2582 gaps (52.2%)

Malter currents MUON LHCb: recovery with 2% O₂ adding

III. MCE curing procedure is similar to the previous without beam, but in Ar/CO₂/CF₄ (40 : 55 : 5) 2% of Oxygen is added.

Currents from Sr⁹⁰ along the chamber, GAP A

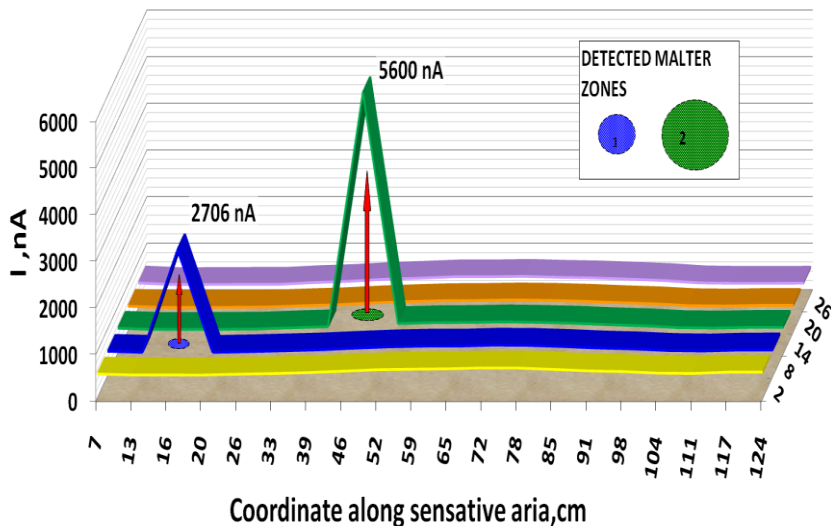

✓ Removal of organic polymeric material with oxygen containing plasma (H. Boeing, Plasma Sci.&Tech., page 281, (1987).

✓ Cleaning of mirrors contaminating films by a glow discharge in oxygen plasma. (R. Gillette et al., Vac. Sci. Tech., 7(1070)534)

✓ Recovery from the Malter effect deposits by Oxygen (A. M. Boyarski, Additives That Prevent Or Reverse Cathode Aging in Drift Chambers With Helium-Isobutane Gas, Nucl. Inst. And Meth. A515, 190-195(2003).

✓ M. Blom, I. Mous, and N. Tuning, Effects of adding oxygen to the outer tracker gas mixture," LHCb, vol. 064, 2008

Curing process of CMB M5R4#22C

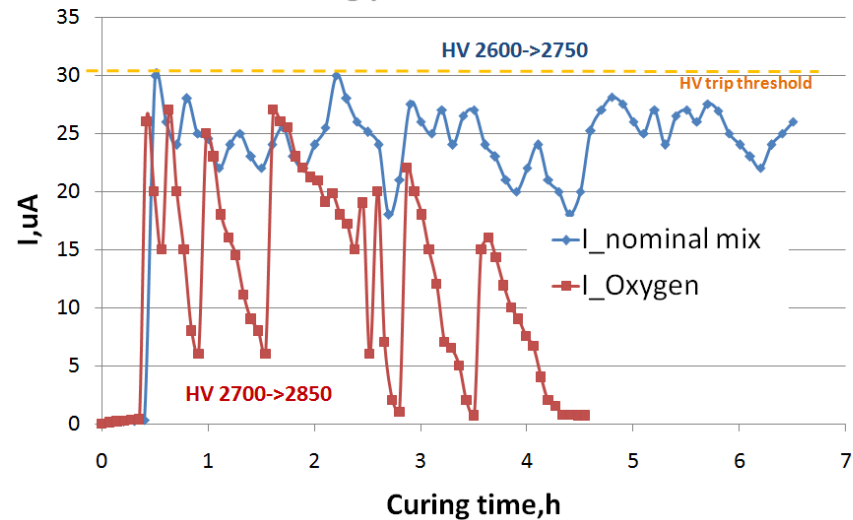

M5R4 #22C

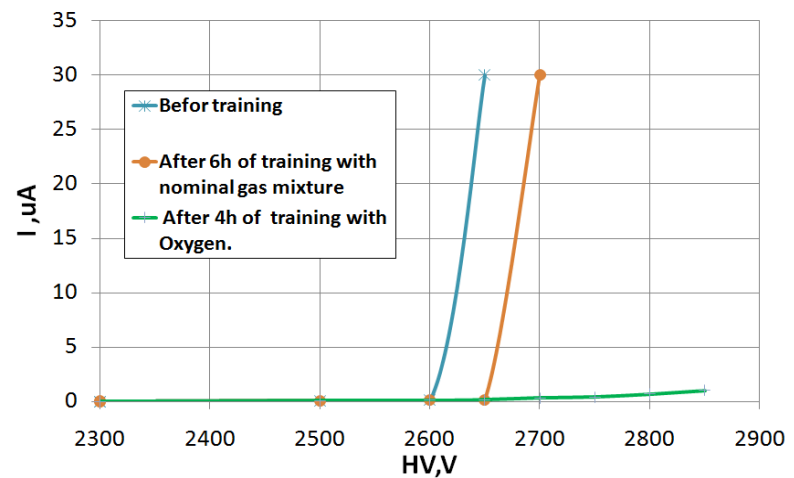

Malter currents: examples observed at CSC CMS

ME1/1: Malter at CMS in p-p collisions

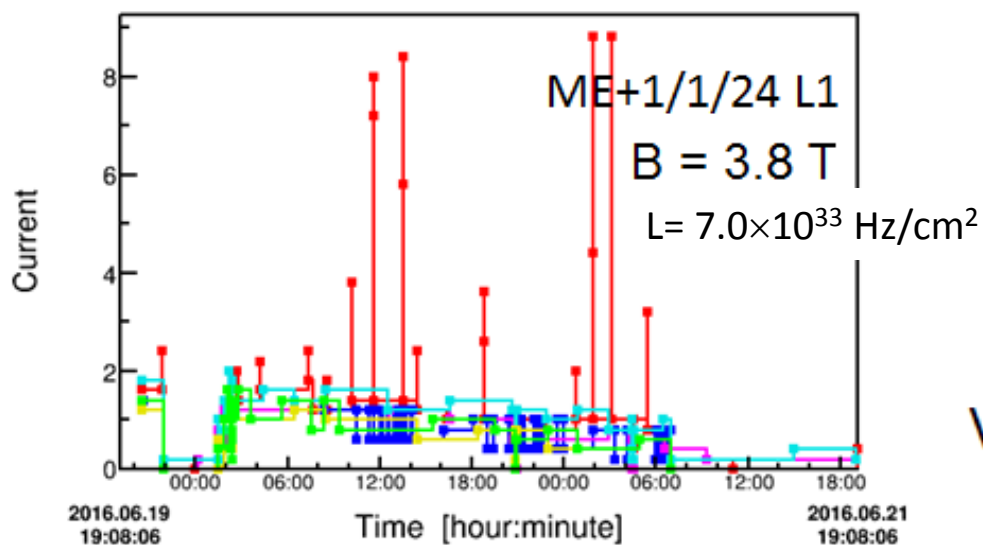
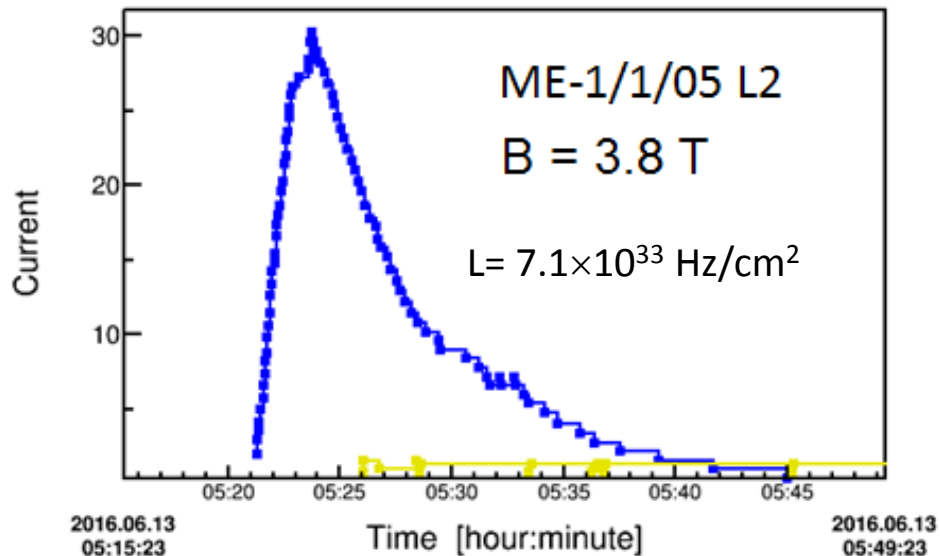

V. Perelygin

Summary:

- **The number of the MCE touched chambers may increase at HL-LHC.**
- **We need an early diagnostic based on HV monitoring system.**
- **From LHCb CSCs experience follows that recovery techniques for CMS CSC's can be useful.**
- **Laboratory tests with small scale prototypes are actual for this purpose.**

Perform testing at the new GIF++ (CERN, North Area)

- **16.7 TBq ^{137}Cs source ($E_\gamma=662$ keV) – 30 times stronger than GIFs**
 - Dose rate 45 mSv/h at $\sim 6\text{m}$
- **Muon, proton, electron secondary beam (H4 beam line)**
 - 6-8 weeks/year SPS beam time allocated to GIF++. Possibility for parasitic beam time
- **100m² irradiation zone**
- **Can uniformly irradiate several detectors in parallel (CSC, RPC, GEM)**
 - Establishing high level of coordination among CMS groups
- **Rates allow to collect ~ 1.5 (ME1/1) and ~ 2 (ME2/1) C/cm in ~ 6 months (50% duty factor). Should provide the needed safety margin.**
 - Under assumption that aging rate is independent of the radiation dose rate
- **Muon beam to do performance studies in high radiation environment**

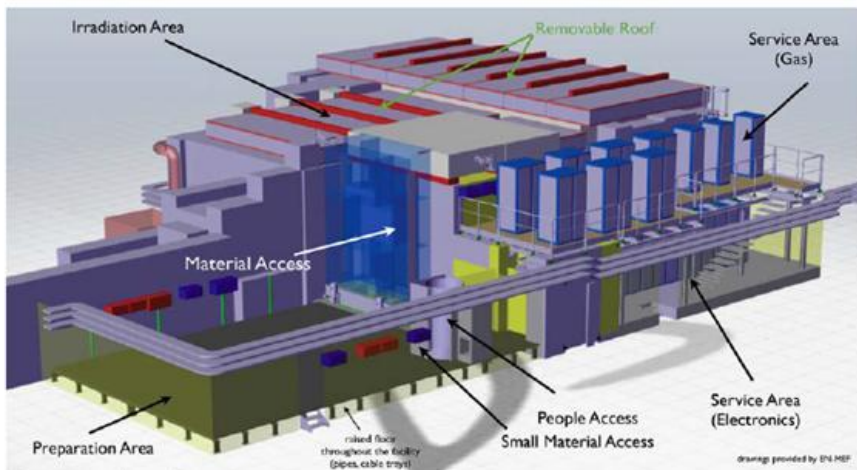

Malter currents: at GIF++

Malter currents (GIF++ off) versus Dose

ME11

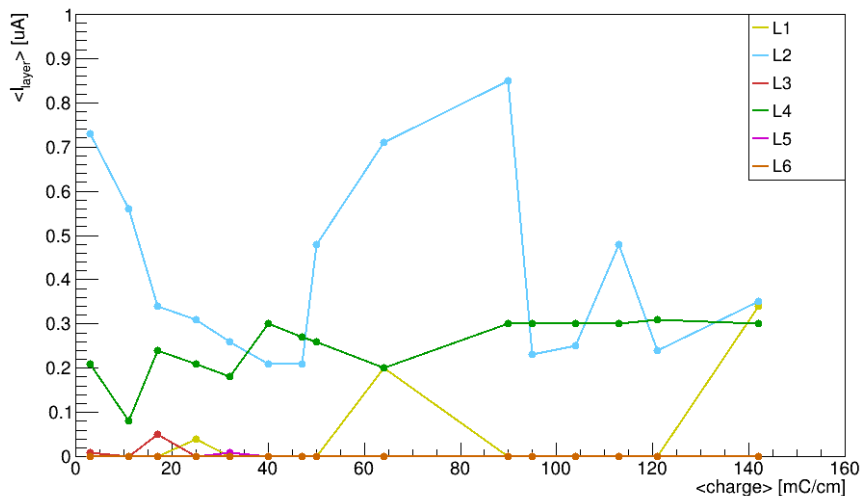

ME21s2

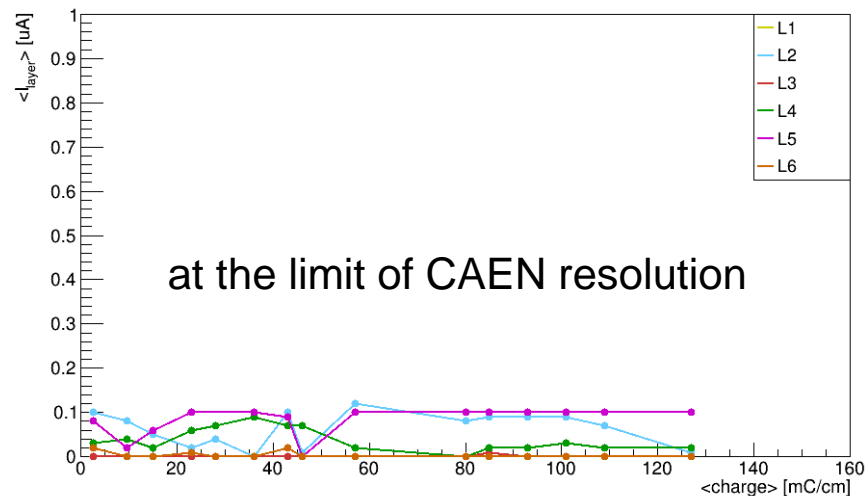

at the limit of CAEN resolution

ME1/1

- tree layers with Malter behavior
- two of them under irradiation
- on in a good correlation with occupancies

**no accumulated charge dependence
seen so far**

ME2/1

- one channel with an obvious Malter current
- in a good correlation with rates

whether improves with time?.. will see...

ME21s3

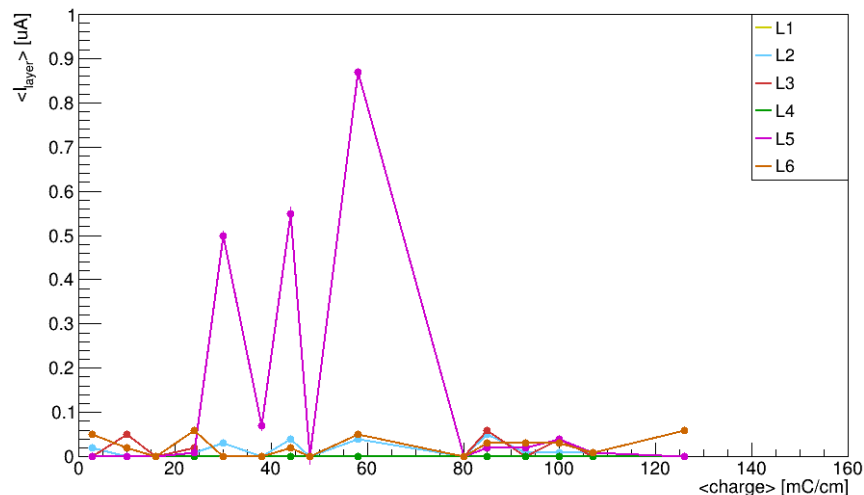

K. Kuznetsova

Malter currents: ME1/1 example at GIF++

Note: current under irradiation (5 μA) is about 3 times smaller than that expected at HL-LHC

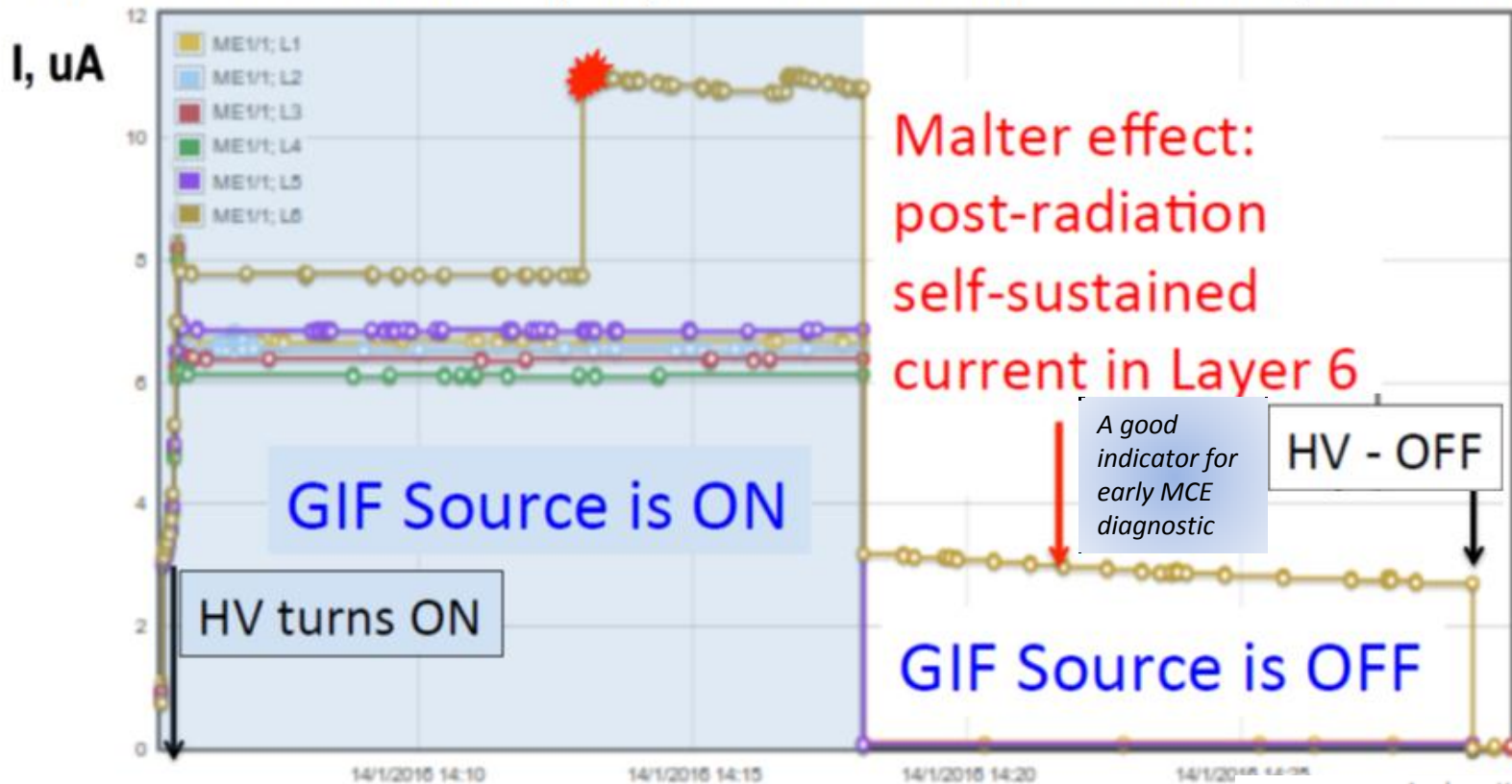

Note: It is one of three ME1/1 from CMS re-tested at GIF++ to localize MCE

Andrey Korytov (UF)
September 13, 2016
CSC Meeting (CMS Physics Week)

CSCs SUMMARY

- ❑ Malter currents potentially can deliver a local charge per unit of wire length $O(1000)$ times larger than that due to the nominal HL-LHC irradiation in the hottest chamber areas.

- ❑ We plan to develop a standard analysis of HV data looking for appearance of Malter currents in each fill and their evolution over time:
 - *large steps in currents during fills*
 - *residual currents right after end of fills and before HV goes to standby.*

- ❑ Early detection of Malter currents and development of mitigating action upon their identification is absolutely vital for the longevity of CSCs.

- ❑ Local fast aging study using the small scale CSC prototypes both in CERN and PNPI is necessary to study the phenomena, develop recovery techniques and to look for eco-friendly gas mixture.



Targeting aging test in PNPI

- **Local aging test under ^{90}Sr irradiation is performed with compact CSC prototype module fed by standard CSC gas mixture;**
- **Accumulated charge 1.36 C/cm is obtained, that is 7x of the expected charge after 3000 fb^{-1} at HL-LHC. The absence of amplitudes degradation matches with the previous tests;**
- **Strip-to-strip resistance dropped during the aging test from $5 \times 10^{13} \Omega$ up to $5 \times 10^7 \Omega$;**
- **Despite of the strong oxidation and Si coating on cathodes surface, no MCE manifestation have been detected;**
- **Test results can be a benchmark for the future study of the eco-friendly gas mixtures;**



Small scale CSC prototype module for aging study

- 2 planes, each with 7 controlled anode wires;
- 50 μm gold-coated anode wire;
- 285 x 340 mm² sensitive area, 1670 cm³ gas volume;
- $S = 3 \text{ mm}$;
- $L = 4.5 \text{ mm}$;
- Identical geometry and construction materials to CSC ;
- Strip resistance control at specially cut strips on the cathode plane ;
- Gas flow during aging test was 4 sccm, that is ~ 3.5 Volume per day ;
- No gas recirculation was applied.

BUT

- * Readout from anode wires only ;
- * - HV applied to the cathode.

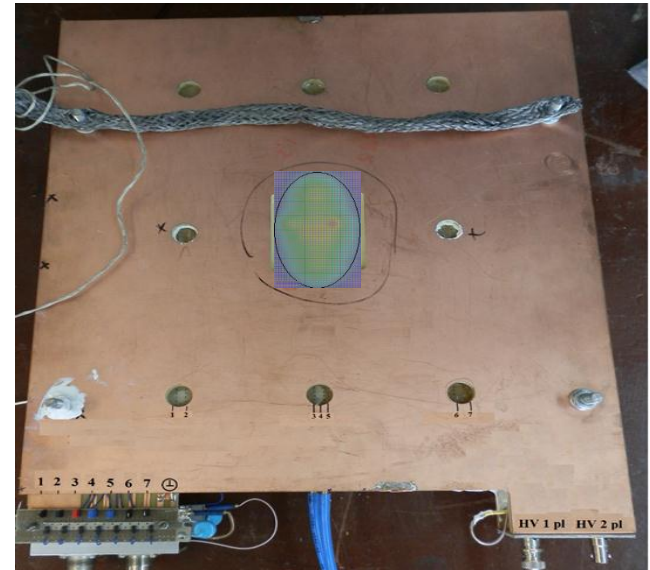
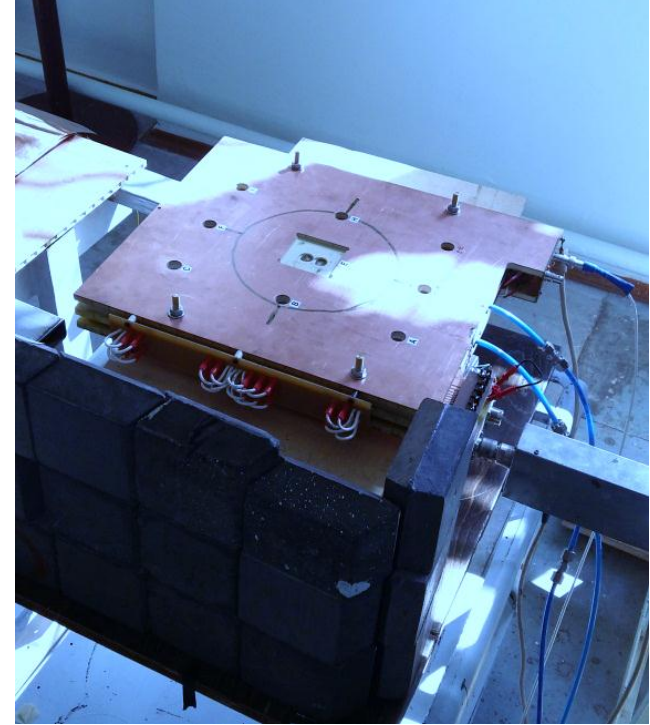



CSC CMS prototype longevity test

Charge accumulation rate: ~ 0.1 C/cm/day

- Monitoring/measurements:
- Relative gain (^{55}Fe peak position);
- Dark current/count;
- Strip-to-strip resistance.

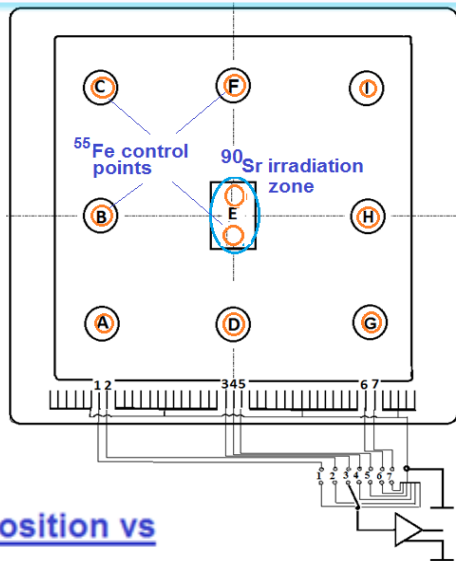

Motivation:

- Targeting test up to $Q \sim 1.5$ C/cm for longevity evaluation at HL-LHC luminosity;
- Benchmark test for new gas mixtures studies;
- Study of the cathode aging phenomena.

Relative gas gain as ^{55}Fe peak position vs accumulated charge

HV = 3750

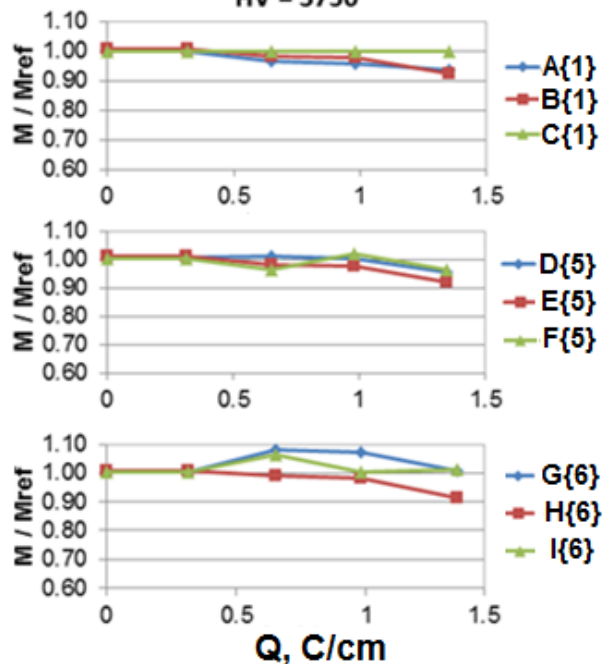

Reference layer after aging run

Irradiated layer after $Q=1.36$ C/cm

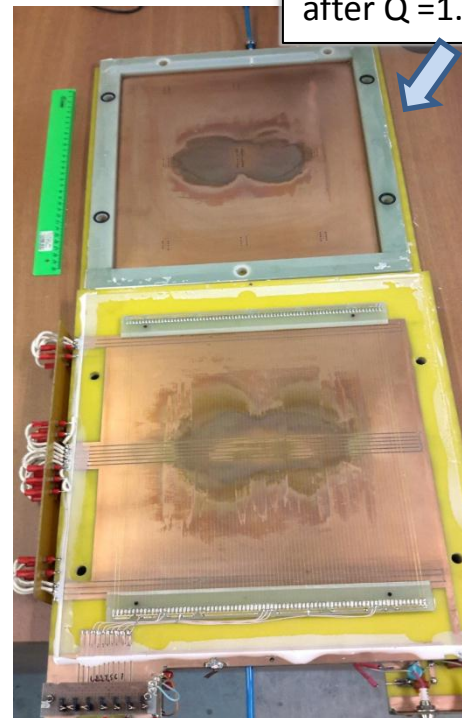
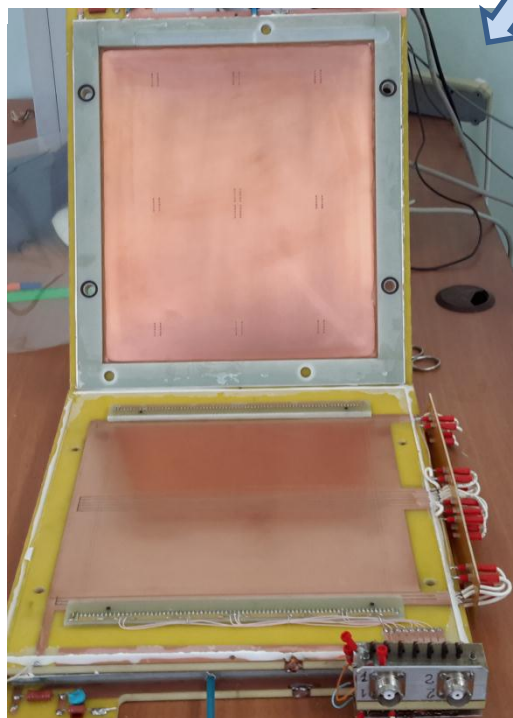



CSC CMS prototype longevity test

Dark current / dark rate measurements

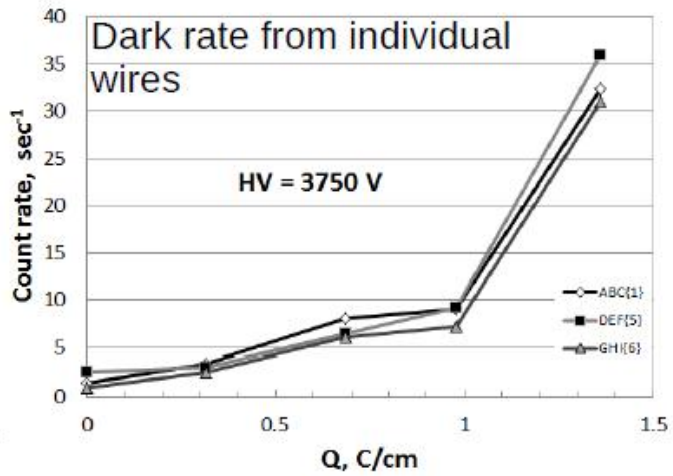
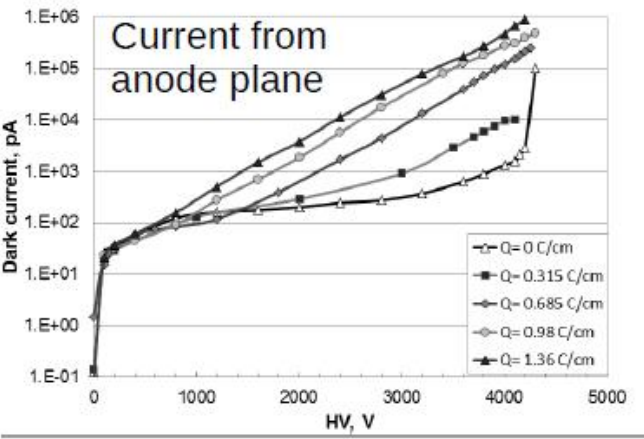

Similar increase of the rate from irradiated {5} and not irradiated {1,6} wires

- sign of cathode deposits

Interstrip resistance

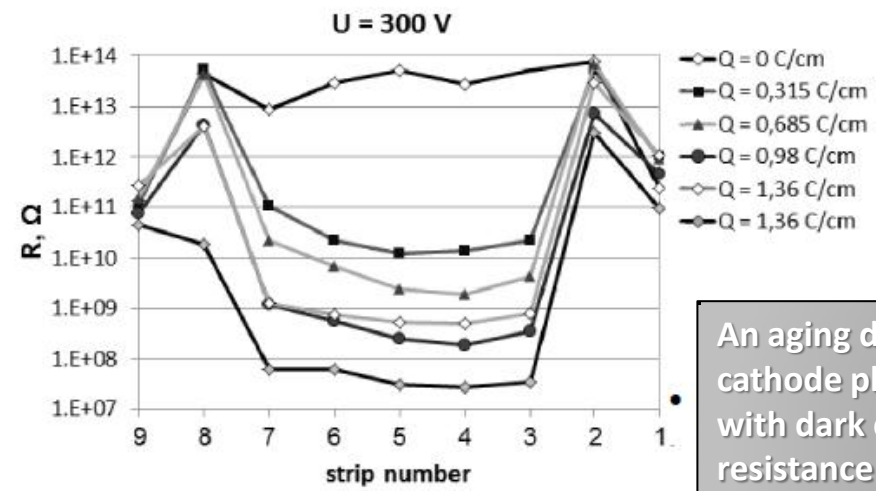

Strips#9,#1 – at the edges of the chamber

An aging degradation is observed on the cathode planes. This manifested itself with dark currents and interstrip resistance drop. **But**. Gas gain stayed stable and no HV trips observed !

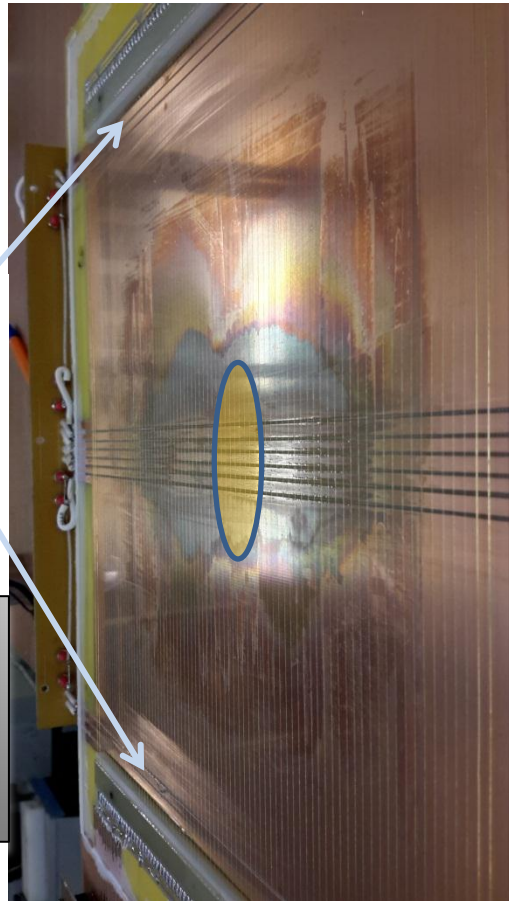

CSC CMS prototype longevity test

Photos of the disassembled detector after accumulation of $Q=1.36 \text{ C/cm}$

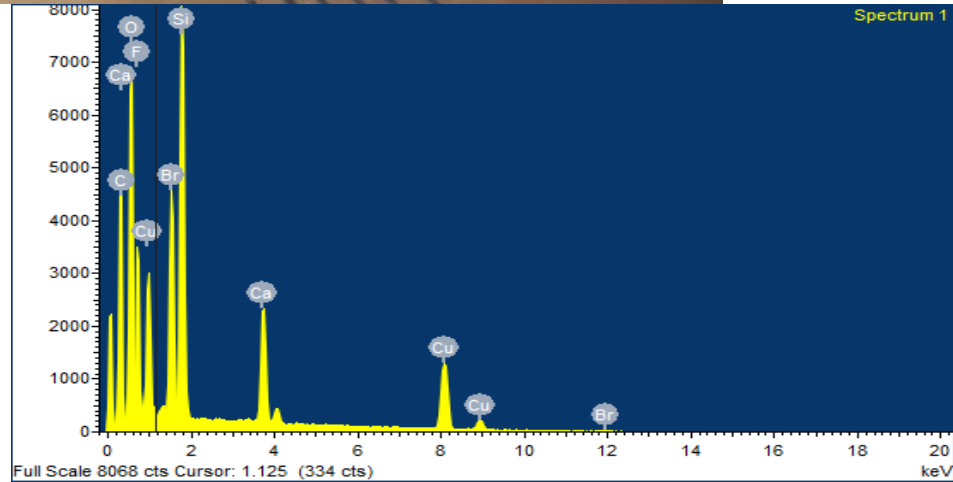
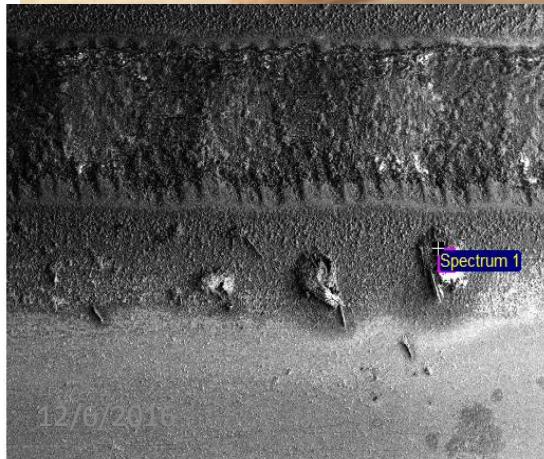
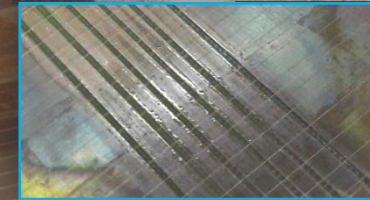
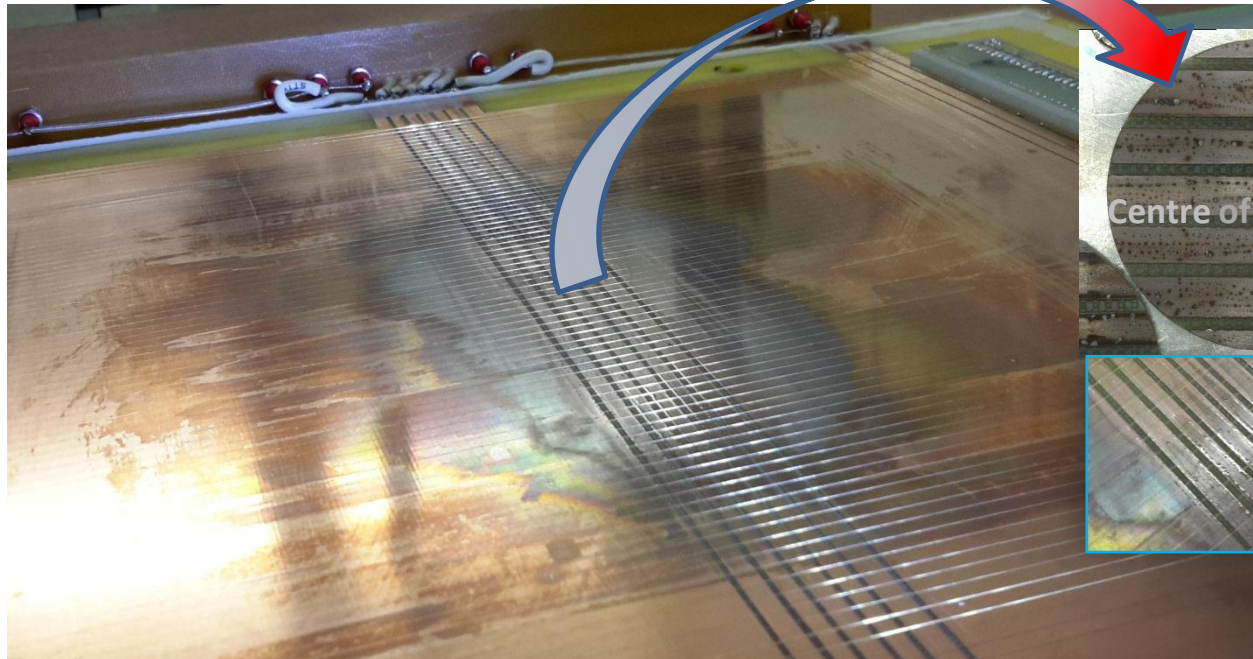



CSC CMS prototype longevity test

SCHEME OF THE TEST POINTS FOR ANALYSIS

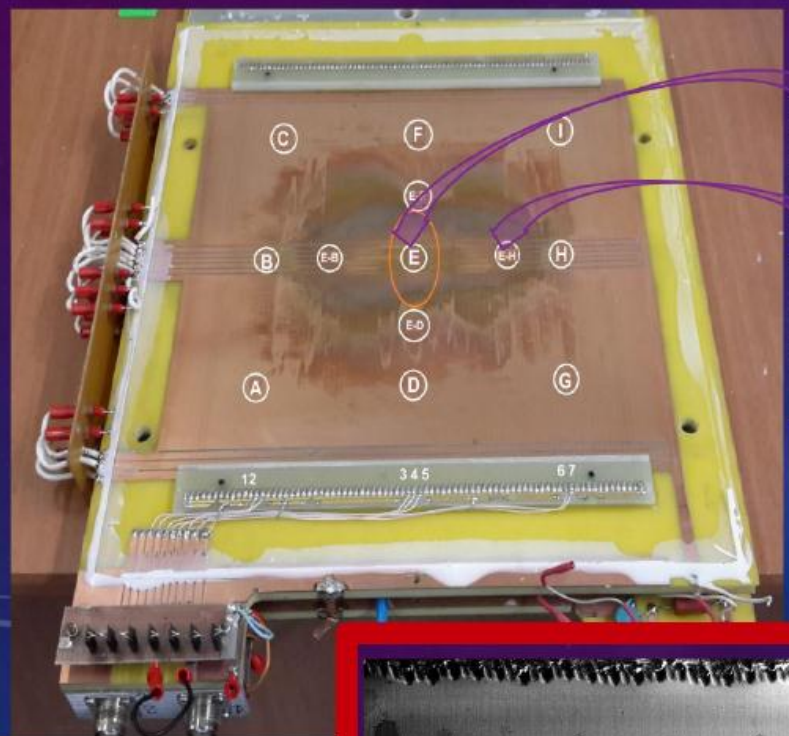

Sample "E":
Cu, O, Si, F

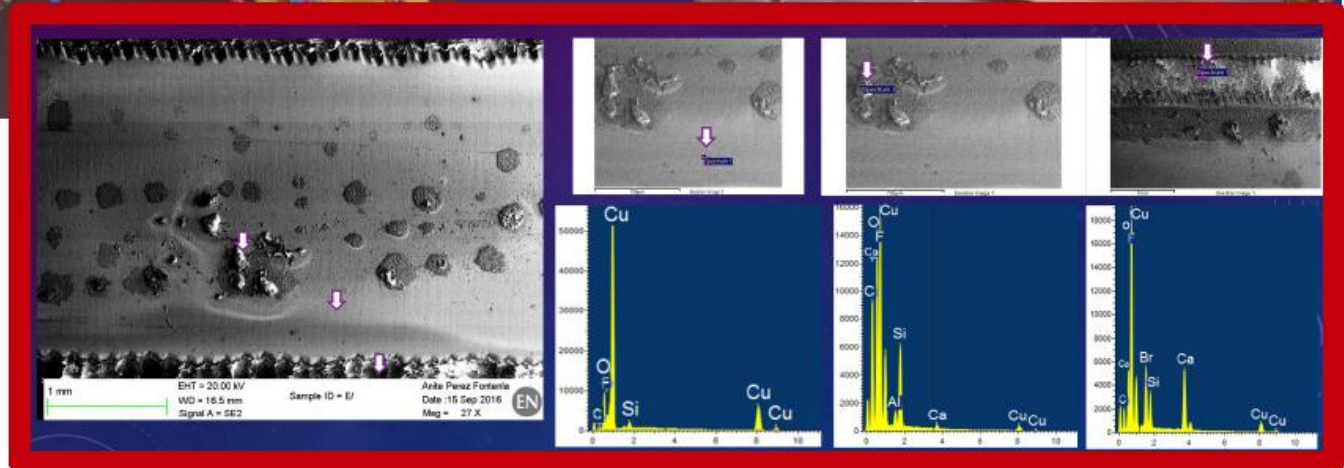

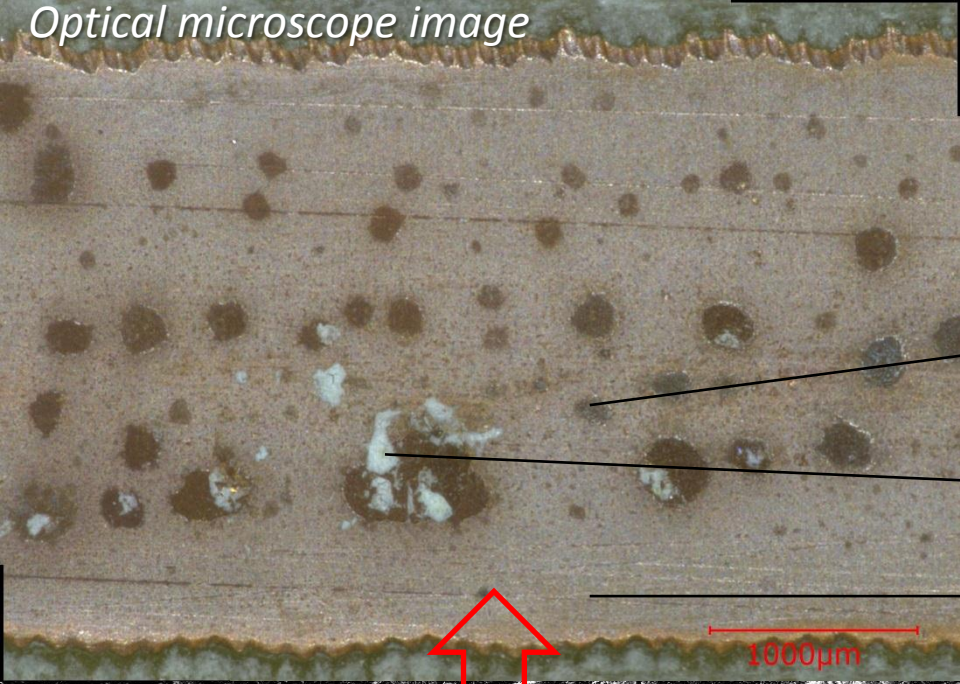

Sample E

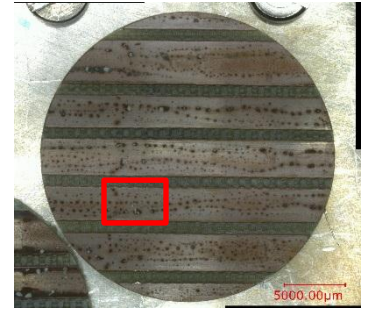

- Dark spot rich F, O and C with Si traces
- White substance rich F, C and O with Si and Ca traces
- Relatively clean area rich in Cu, O, F, C and Si traces

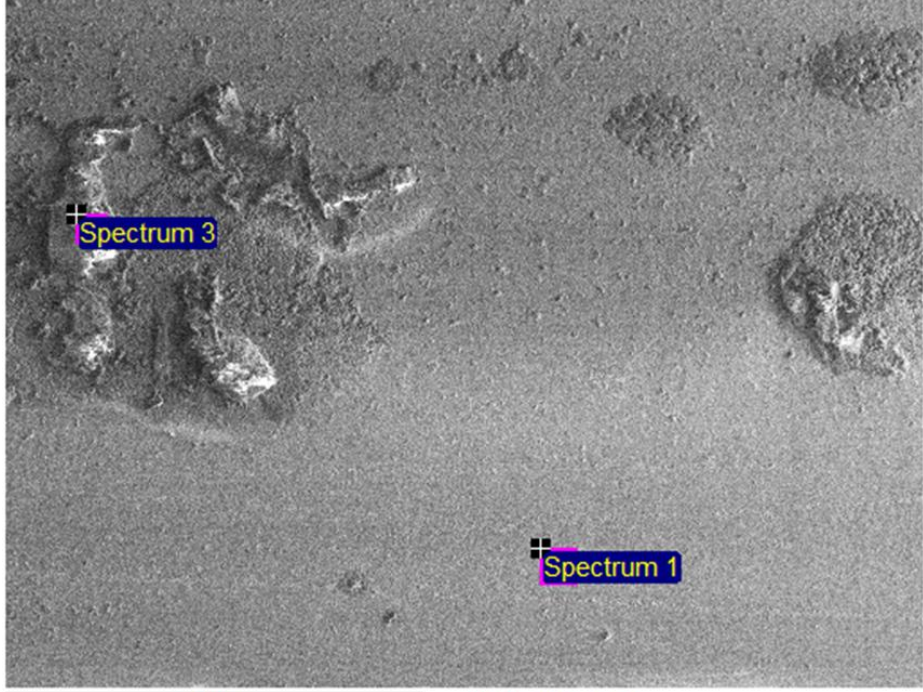
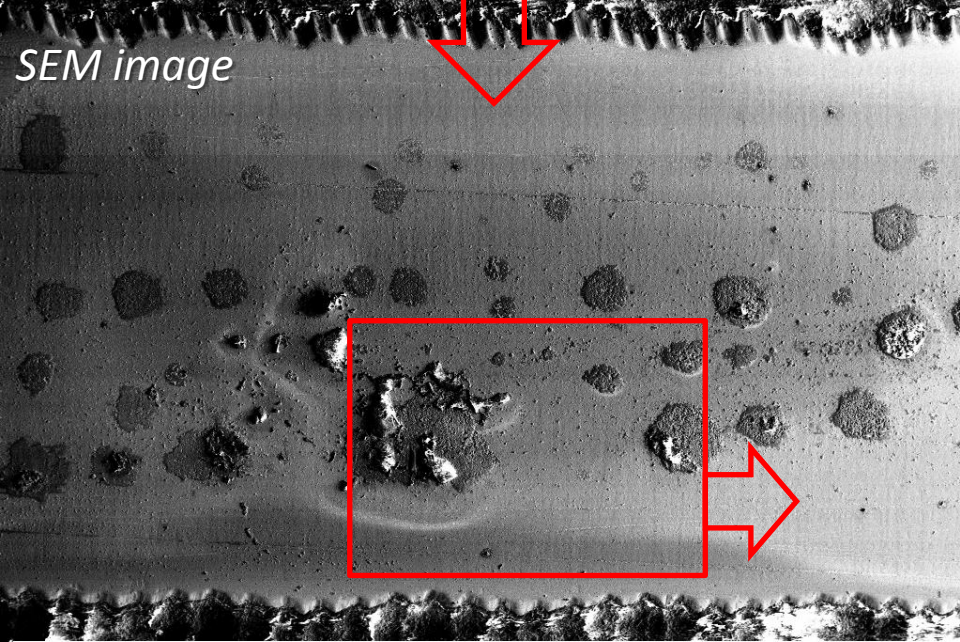

1 mm
EHT = 20.00 kV
WD = 16.5 mm
Signal A = SE2
Sample ID = E/
Anite Perez Fontenla
Date :15 Sep 2016
Mag = 27 X



Electron Image 1



CSC CMS prototype longevity test

- Small ($<0.1\text{cm}^2$) samples from E and B-I (most irradiated and “reference”)
- Zeiss XB540 FIB/SEM with Oxford Instruments X-Max Silicon Drift Detector
- Use of FIB=“Focused Ion Beam” for milling a x-section

Sample E - surface

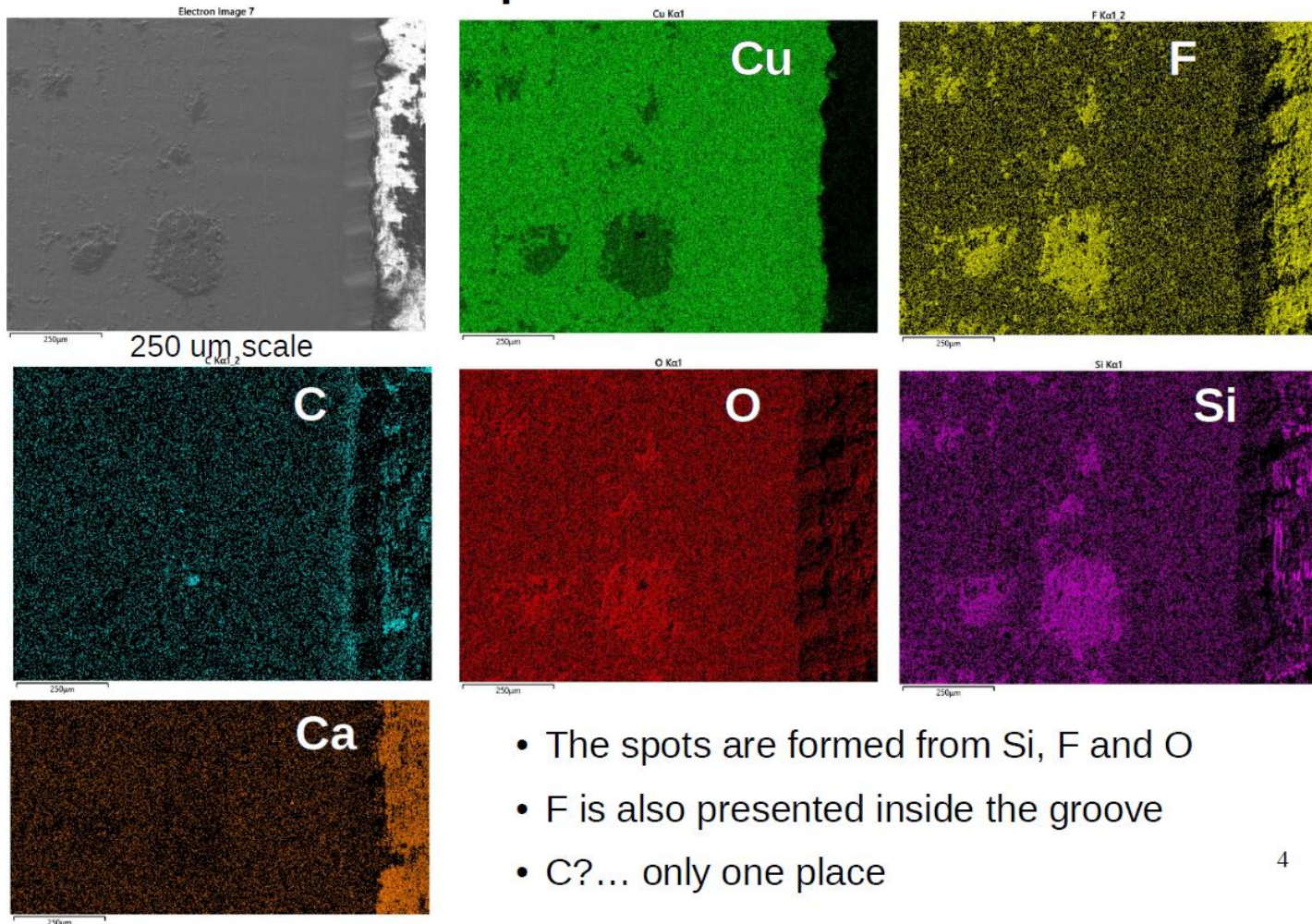

- The spots are formed from Si, F and O
- F is also presented inside the groove
- C?... only one place



Sample B-I - surface

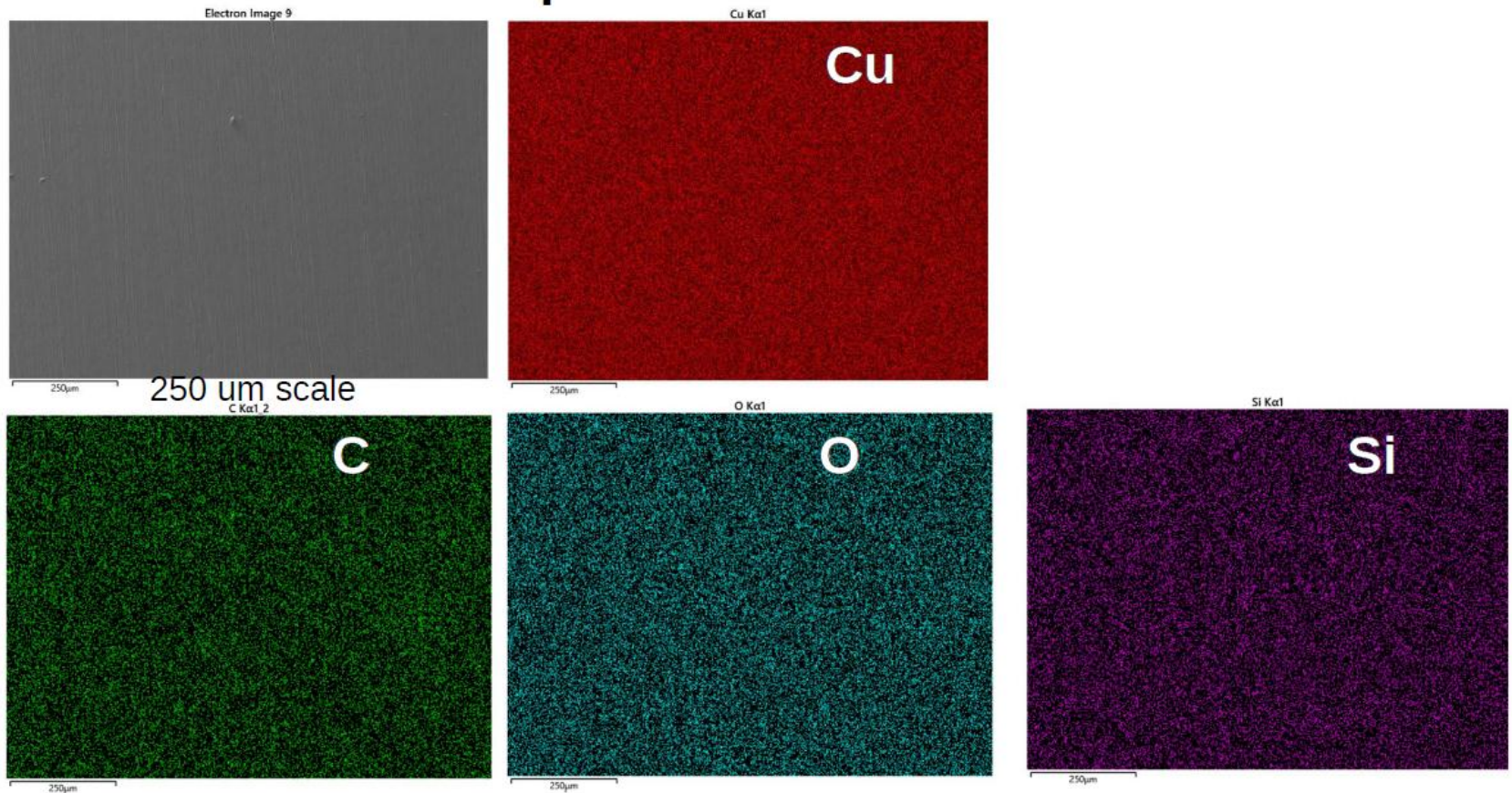

Weight fractions averaged over analysis surface (indicative ONLY!)

Element	Cu (wt%)	O (wt%)	C (wt%)	F (wt%)	Si (wt%)	Ca (wt%)
Sample B-I	84.5 ± 0.1	3.0 ± 0.0	12.3 ± 0.1	0.0	0.3 ± 0.0	0.0
Sample E	73.4 ± 0.1	11.5 ± 0.0	8.0 ± 0.1	4.6 ± 0.1	1.8 ± 0.0	0.7 ± 0.0

5

Sensitivity depth – O(um), different for different elements!

GHG for particle detection at LHC

A greenhouse gas is any gaseous compound that is capable of absorbing infrared radiation, thereby trapping and holding heat in the atmosphere

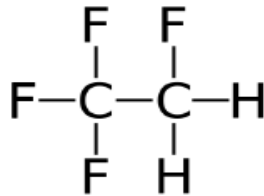

GWP 1430

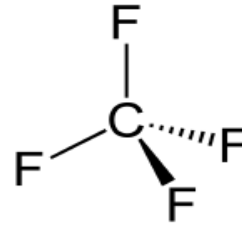

GWP 5700

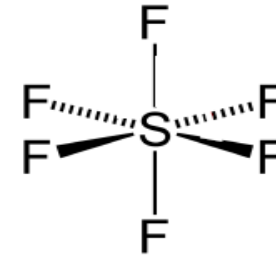

GWP 22200

GWP is a relative measure of how much heat a greenhouse gas traps in the atmosphere

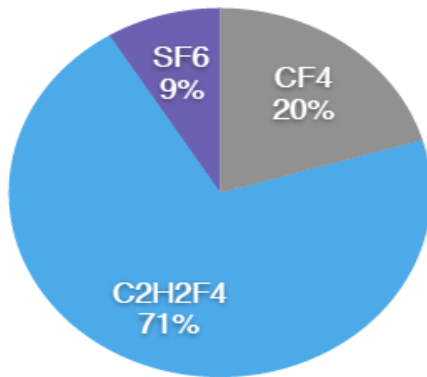

Total GHG contribution

European Union “F-gas regulation”:

- **Limiting the total amount** of the most important F-gases that can be sold in the EU from 2015 onwards and phasing them down in steps to one-fifth of 2014 sales in 2030.
- **Banning the use** of F-gases in many new types of equipment where less harmful alternatives are widely available.
- **Preventing emissions** of F-gases from existing equipment by requiring checks, proper servicing and recovery of the gases at the end of the equipment's life.



Eco-gas R&D studies

- In previous talks on this subjects a number of possible candidates for replacing CF_4 were proposed
- Collaborators at PNPI have began investigating properties of such gases when used in $\text{Ar}+\text{CO}_2$ based gas mixtures

Molecular name	Chemical formula	CAS	Refrigerant identifier	GWP	Life time in atmosphere, years
Carbon Dioxide	CO_2	124-38-9	R744	1	50-200
Tetrafluoromethane	CF_4	75-73-0	R14	7390	50000
Trifluoroiodomethane	CF_3I	2314-97-8	R13I	0	<1
Hexafluoroethane	C_2F_6	76-16-4	R116	12200	10000
Octafluoropropane	C_3F_8	76-19-7	R218	8830	7000
Octafluorocyclobutane	c- C_4F_8	115-25-3	RC318	10300	3000

- All these gases are used for dry plasma etching primarily related to silicon technology in microelectronics
- CF_3I has comparable Si-etching properties as CF_4 . So it is a good candidate

New regulations on greenhouse gas emission could hit us as soon as 2025 (40% reduction) and 2050 (100%).

⁵⁵Fe count rates across straw

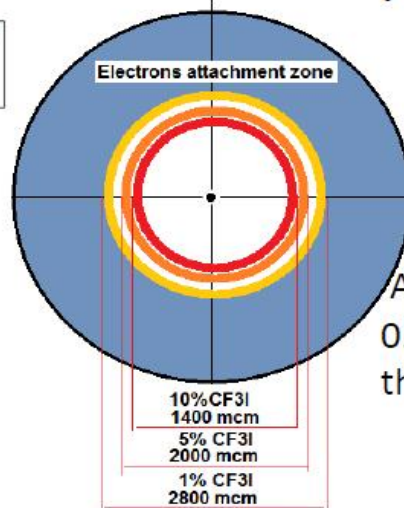
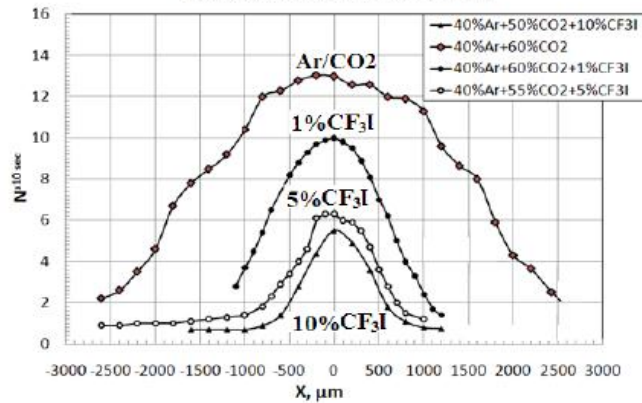

- Detectors operate in limited streamer mode with high amplification around anode wire

Reason:

Attachment for electrons $E \sim 0.01-0.5$ eV in CF₃I is 200 higher than in CF₄

G. Gavrilov (PNPI)

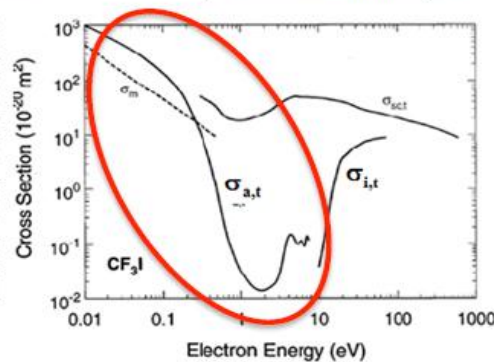
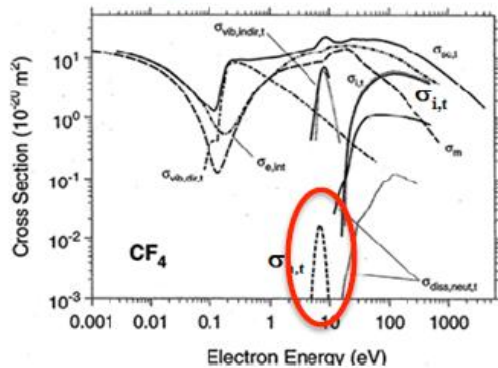

CF₃I:

- Insensitive to cathode aging (e⁻ emission from Malter effect)
- High signal amplitude due to limited streamer mode
- High angle resolution
- With low CF₃I concentrations could extend HV plateau by adding additives (methane)

Наконец заключение

- ❑ Появление токов Мальтера (МЭ) в катодных пропорциональных камерах CSC мюонного трекера CMS стало наблюдаемой реальностью. Ситуация может ухудшиться после перехода коллайдера LHC на более высокую светимость в режим HL-LHC ($5 \times 10^{34} \text{ см}^{-2} \text{ сек}^{-1}$).
- ❑ Методы устранения МЭ – тренировки есть и они успешно испытаны. Но только на детекторах в эксперименте LHCb.
- ❑ Нет пока результатов восстановления для камер CSC. Ведутся попытки восстановления отдельных модулей (которые имели МЭ с момента работы на LHC) на на GIF++. Планируется проводить разработку методов восстановления и в ОФВЭ ПИЯФ.
- ❑ Возможности быстро, до 2025 г., создать экологически безопасную газовую смесь для камер CSC, видимо, нет. Но можно радикально сократить размеры выбросов парниковых газов мюонного трекера CMS. Эти работы ведутся в ОМК ОФВЭ.

BACKUPS

FIB x-section – E-2

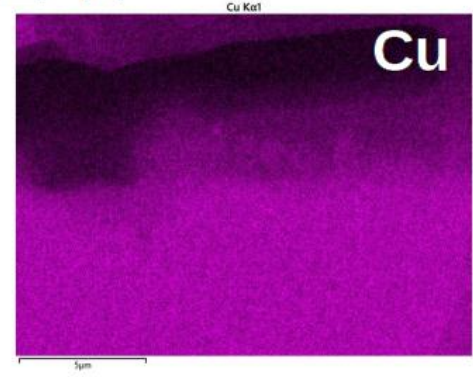
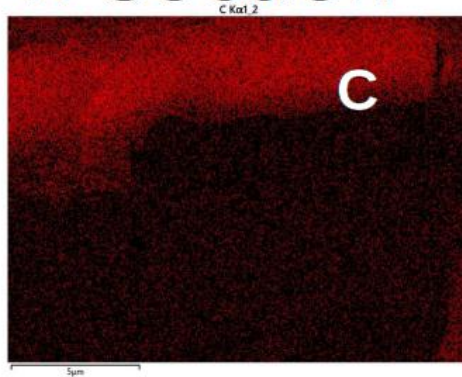
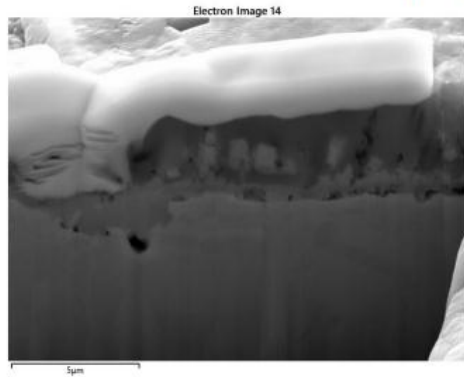

5 um scale

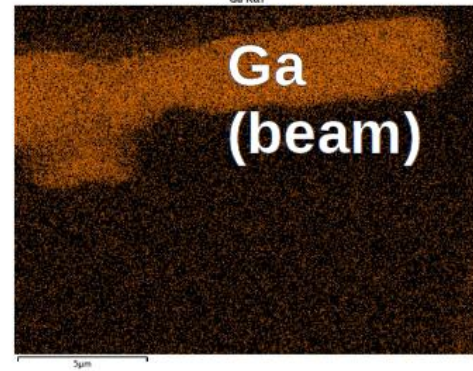
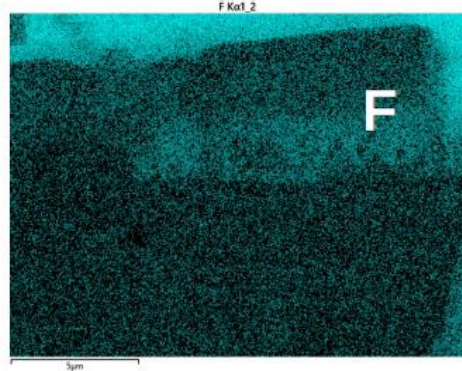
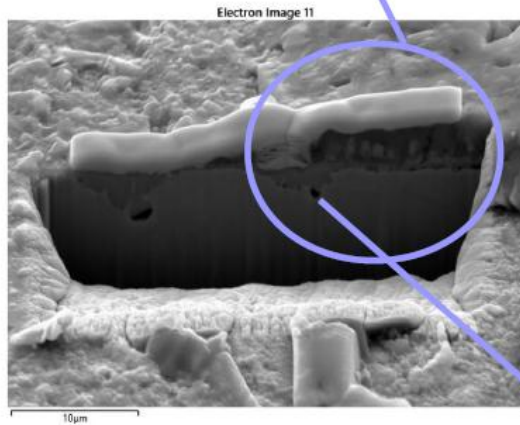

10 um scale

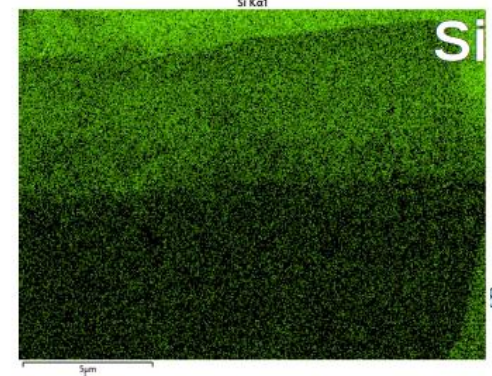
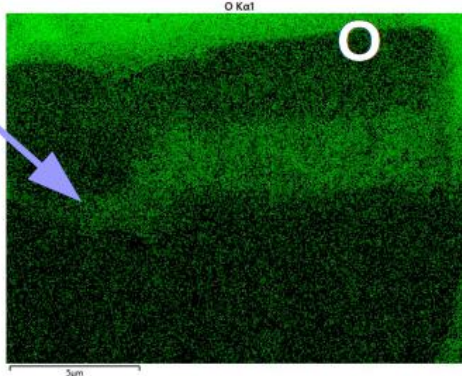

FIB x-section – H-I - reference

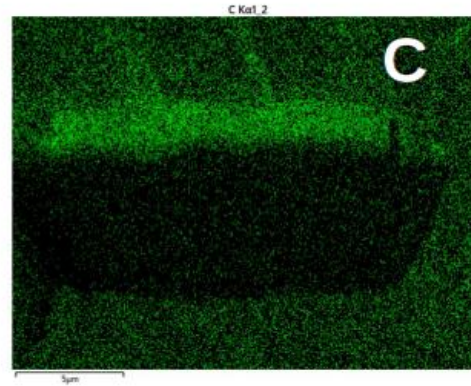
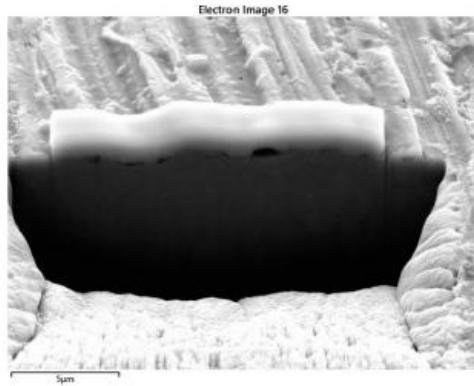

- No non-uniformities observed
- Very slight variation of O and C within surface structure?..

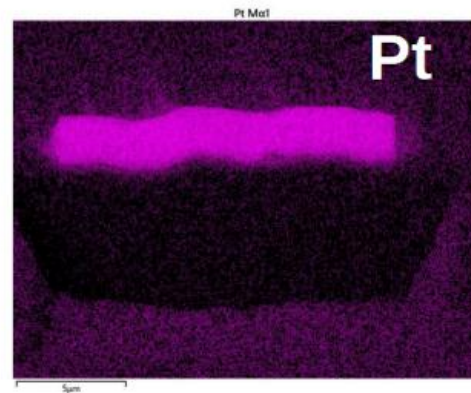
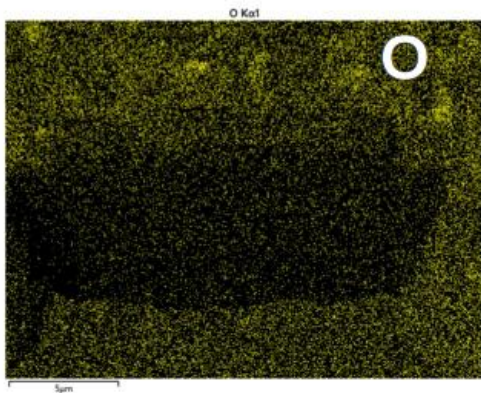
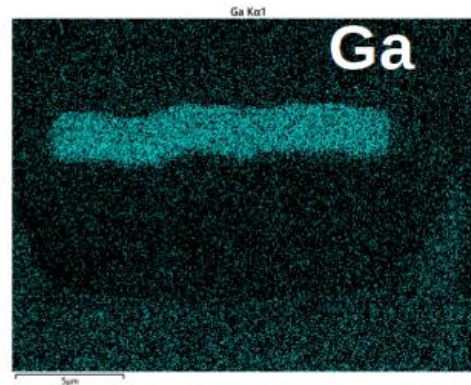
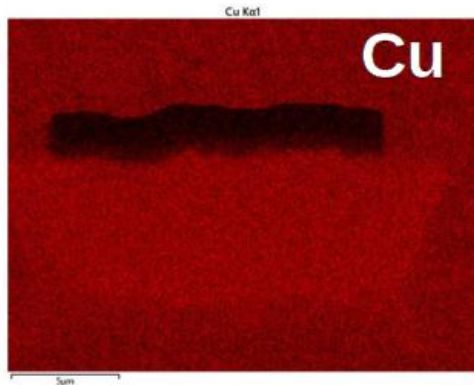

Aging results from GIF (1999)

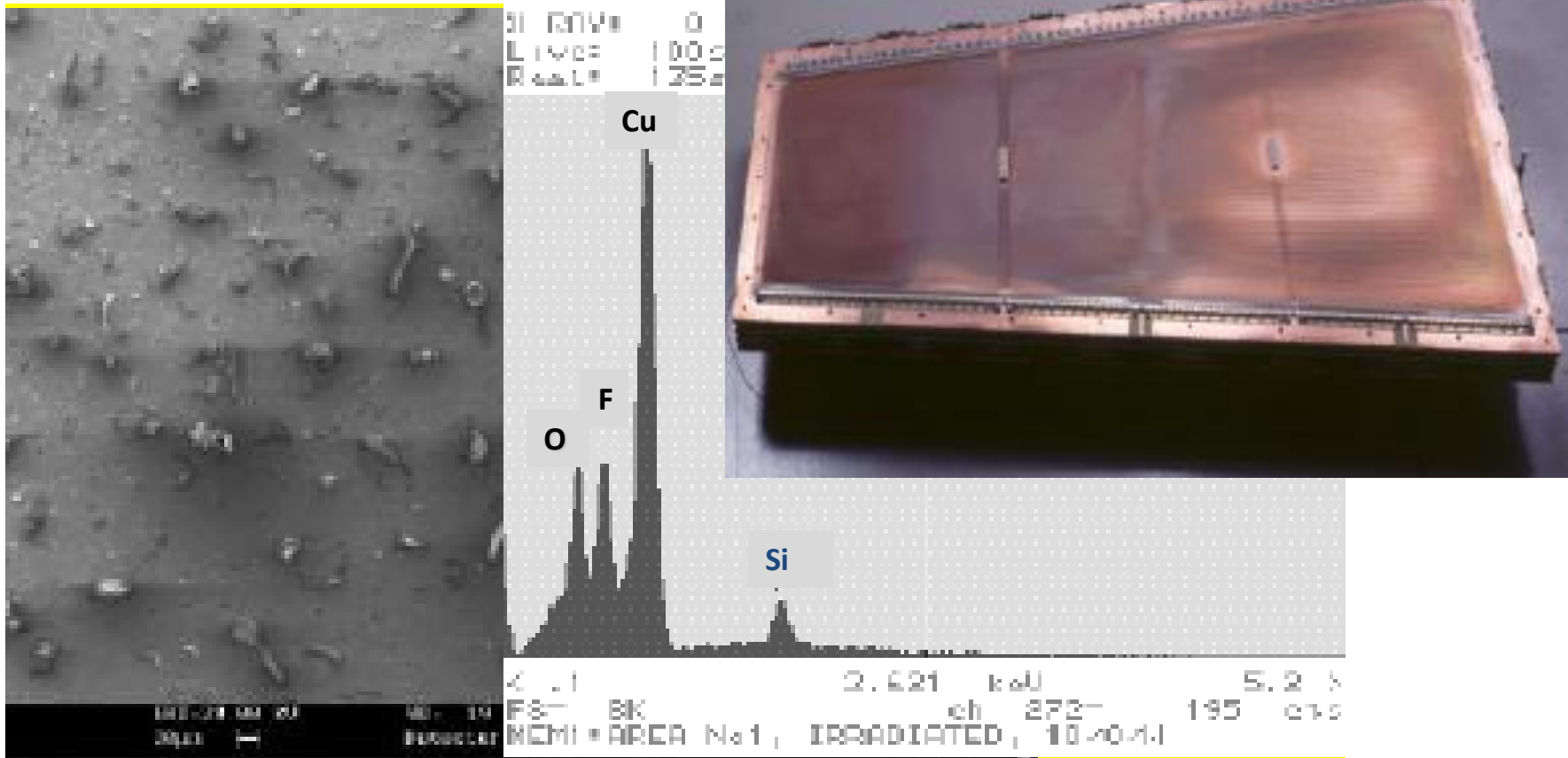

D. Acosta et al. NIMA 515 (2003) 226–233

SEM image of the copper surface of original not irradiated FR4

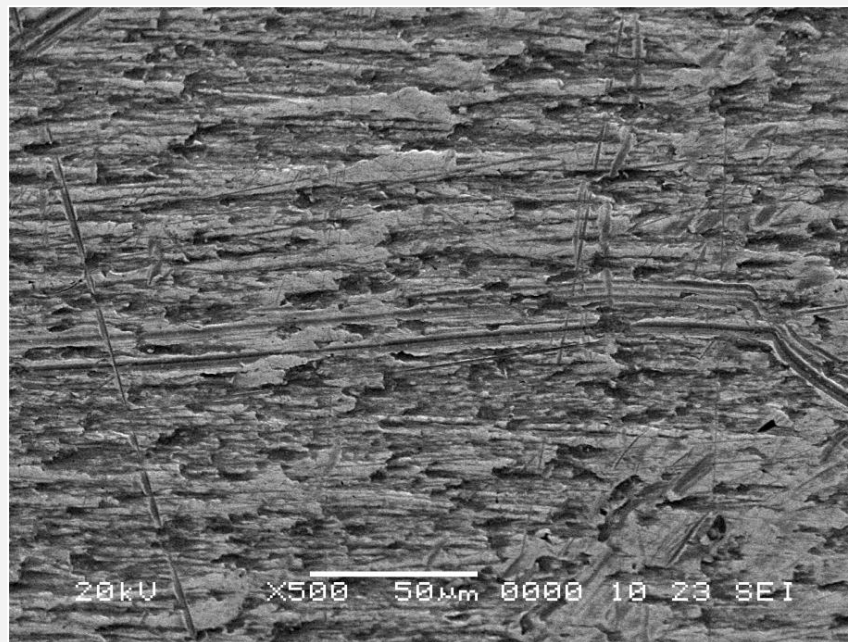

Force microscopy of original FR4

